

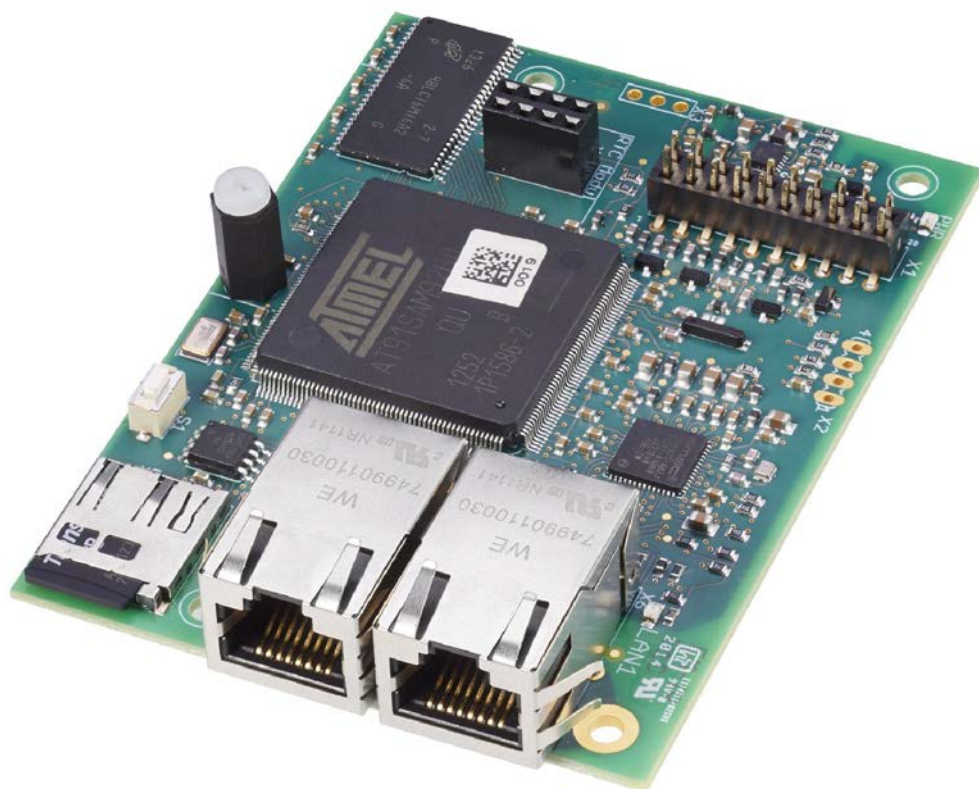

Expansion module

EM-IP

Description of data points for the BACnet/IP- or Modbus/IP interface for EASYLAB/TROX UNIVERSAL Firmware from 2.0



Read the instructions prior to performing any task!

TROX GmbH

Heinrich-Trox-Platz

47504 Neukirchen-Vluyn, Germany

Germany

Telephone: +49 2845 202-0

Fax: +49 2845 202-265

email: trox@trox.de

Internet: <http://www.troxtechnik.com>

A00000051268, 3, GB/en

06/2019

© TROX GmbH 2017

About this manual

Expansion module EM-IP is used to integrate the following devices into an IP-based network and connect them to the central BMS using the BACnet/IP or Modbus/IP protocol:

- EASYLAB controller TCU3
- EASYLAB adapter modules TAM
- TROX UNIVERSAL CONTROLLER

This configuration manual is an addition to the installation manual and contains information on how to configure EM-IP as an interface to the central BMS.

Illustrations in this manual are mainly for information and may differ from the actual design of EM-IP.

Other applicable documentation

In addition to these instructions, the following documents apply:

- Installation manual for expansion module EM-IP
- Documentation on
 - EASYLAB controller TCU3
 - Adapter module TAM
 - TROX UNIVERSAL CONTROLLER
- Project-specific wiring documents, if any

TROX Technical Service

To ensure that your request is processed as quickly as possible, please keep the following information ready:

- Product name
- TROX order number
- Delivery date
- Brief description of the fault

Online	www.troxtechnik.com
Phone	+49 2845 202-400

Limitation of liability

The information in this manual has been compiled with reference to the applicable standards and guidelines, the state of the art, and our expertise and experience of many years.

The manufacturer does not accept any liability for damages resulting from:

- Non-compliance with this manual
- Incorrect use
- Operation or handling by untrained individuals
- Unauthorised modifications
- Technical changes
- Use of non-approved replacement parts

The actual scope of delivery may differ from the information in this manual for bespoke constructions, additional order options or as a result of recent technical changes.

The obligations agreed in the order, the general terms and conditions, the manufacturer's terms of delivery, and the legal regulations in effect at the time the contract is signed shall apply.

We reserve the right to make technical changes.

Defects liability

For details regarding defects liability please refer to Section VI, Warranty Claims, of the Delivery and Payment Terms of TROX GmbH.

The Delivery and Payment Terms of TROX GmbH are available at www.troxtechnik.com.

Copyright

This document, including all illustrations, is protected by copyright and pertains only to the corresponding product.

Any use without our consent may be an infringement of copyright, and the violator will be held liable for any damage.

This applies in particular to:

- Publishing content
- Copying content
- Translating content
- Microcopying content
- Saving content to electronic systems and editing it

1	Security	5	7	Index	76
	1.1 Correct use.....	5			
	1.1.1 Incorrect use.....	5			
	1.2 Safety signs.....	5			
	1.3 Residual risks.....	5			
	1.4 Risk of damage to property.....	6			
	1.5 System owner's responsibility.....	6			
	1.6 Qualified staff.....	6			
	1.7 Environmental protection.....	6			
2	Configuration	8			
	2.1 IP configuration.....	8			
	2.2 Required software version.....	8			
	2.3 Functions of the Reset push button.....	8			
	2.3.1 Rebooting EM-IP.....	8			
	2.3.2 Resetting the default IP address.....	8			
	2.3.3 Activating the DHCP server.....	8			
	2.3.4 Restoring the factory settings	9			
3	Web server settings	10			
	3.1 Supported browsers.....	10			
	3.2 Standard IP addresses.....	10			
	3.3 Supported users.....	10			
	3.4 Displaying the configuration manual as PDF document.....	10			
	3.5 Web server navigation.....	11			
	3.5.1 Accessing the web interface.....	11			
	3.5.2 Login.....	11			
	3.5.3 Menu navigation.....	11			
	3.5.4 Functions of the 'Plants' menu.....	12			
	3.5.5 Functions of the 'Events' menu.....	14			
	3.5.6 Functions of the 'Analysis' menu.....	14			
	3.5.7 Functions of the 'Setup' menu.....	15			
	3.5.8 Functions of the 'Help' menu.....	25			
4	Interface information	26			
	4.1 BACnet interface.....	26			
	4.2 Modbus interface.....	37			
	4.3 Data points – detailed description.....	47			
	4.3.1 Input variables.....	47			
	4.3.2 Output variables.....	51			
5	Maintenance	71			
	5.1 Maintenance plan.....	71			
	5.2 Maintenance.....	71			
	5.2.1 Replacing the battery of the RTC module.....	71			
	5.2.2 Replacing the EM-IP expansion module.....	72			
	5.2.3 Before re-commissioning.....	74			
6	Fault displays	75			
	6.1 LED status display.....	75			
	6.2 Webserver.....	75			

1 Security

Safety notes

Symbols are used in this manual to alert readers to areas of potential hazard. Signal words express the degree of the hazard.

DANGER!

Imminently hazardous situation which is due to live components and which, if not avoided, will result in death or serious injury due to electrical voltage.

DANGER!

Imminently hazardous situation which, if not avoided, will result in death or serious injury.

NOTICE!

Potentially hazardous situation which, if not avoided, may result in property damage.

ENVIRONMENT!

Environmental pollution hazard.

1.1 Correct use

Expansion module EM-IP provides a BACnet/IP or Modbus/IP interface and a web server interface for EASYLAB base components as well as for the TROX UNIVERSAL CONTROLLER.

Use the expansion module for the following devices:

- EASYLAB controller TCU3
- EASYLAB adapter module TAM
- TROX UNIVERSAL CONTROLLER

1.1.1 Incorrect use

Do not use the expansion module for areas of application that are not described in this manual.

Do not use the expansion module:

- outdoors
- in wet areas
- in areas with potentially explosive atmospheres

Residual risks

Failure of the network interface does not affect the control function of the volume flow controller but does affect data exchange with the central BMS. Safety-related applications require further precautions.

1.2 Safety signs

The following symbols and signs are usually found in the work area. They apply to the very location where they are found.

Electrical voltage



Location where a hazard due to electrical voltage exists.

Earthing



This symbol marks all equipotential bonding connection points on EM-IP.

1.3 Residual risks

EM-IP is a state-of-the-art product and meets current safety requirements. Residual risks cannot be excluded, however, and you should proceed with caution.

Always observe the safety notes in this manual to reduce health hazards and prevent any hazardous situations.

Electric current

DANGER!

Danger of death due to electric current!

Danger of death if live components are touched.

- Switch off the supply voltage and secure it against being switched on again before working on the unit.
- Only skilled qualified electricians are allowed to work on live components.
- Equipotential bonding is required.

1.4 Risk of damage to property

Temperature differences

! NOTICE!

Risk of damage to property due to large temperature differences

If EM-IP has been kept in an unheated area, condensation may form and damage the electronic components beyond repair.

- Let EM-IP warm up to room temperature before you install it.

Electrostatic charge

! NOTICE!

Risk of damage to property due to electrostatic charge

Electrostatic charge can damage the electronics of the expansion module.

- Before you remove the expansion module from its protective wrapping, touch an equipotentially bonded metal surface, e.g. a water pipe, for electrical earthing.
- Avoid skin contact with any components or printed circuits on the expansion module or the main PCB.
- Wear conductive footwear and antistatic clothing.

1.5 System owner's responsibility

System owner's obligations

EM-IP is intended for commercial use. The system owner is therefore subject to the legal obligations of occupational health and safety regulations.

In addition to the safety notes in this manual, the applicable regulations for safety, accident prevention and environmental protection must also be complied with.

1.6 Qualified staff

Qualification

The work described in this manual has to be carried out by individuals with the qualification, training, knowledge and experience described below:

Network administrator

Network administrators design, install, configure and maintain the IT infrastructure in companies or organisations.

Skilled qualified electrician

Skilled qualified electricians are individuals who have sufficient professional or technical training, knowledge and actual experience to enable them to work on electrical systems, understand any potential hazards related to the work under consideration, and recognise and avoid any risks involved.

Any work has to be carried out by individuals who can be expected to carry out their assigned duties reliably. Individuals whose reaction time is delayed due to alcohol, drugs or other medication must not carry out any work.

Passwords

Web server setup is password protected to prevent unauthorised individuals from entering or changing data.

🔗 Chapter 3.3 'Supported users' on page 10

1.7 Environmental protection

The following substances and materials which are hazardous to the environment are used:

Electrical and electronic parts

Electrical and electronic parts may contain toxic materials and substances. These parts have to be disposed of separately from other waste, i.e. taken to your local reuse and recycling centre or disposed of by a specialist disposal company.

Batteries

Batteries contain toxic heavy metals. They are hazardous waste and must be taken to a hazardous waste collection point or disposed of by a specialist company.

2 Configuration

2.1 IP configuration

Most configuration settings for EM-IP can be entered using the integral web server ↪ *Chapter 3 'Web server settings' on page 10.*

Network conflicts

The factory set default IP address and IP configuration of EM-IP may not be entirely compatible with the target network. It may hence be better to first connect EM-IP during commissioning with a network patch cable to the PC and to make the required configuration settings explained in section ↪ *Chapter 3 'Web server settings' on page 10.*

The Reset button (Fig. 1/1) allows you to choose between two IP configurations and the original state at the time of delivery.

If the connected PC is a DHCP client and if there is no DHCP server, the client should generate its own address within 60 seconds.

As a consequence, EM-IP can access the web server even if the network characteristics of the PC are not changed.

2.2 Required software version

The expansion module EM-IP with firmware 2.0 requires the following software versions:

- EASYLAB or adapter module TAM
 - Software version 8.1 or higher
- TROX UNIVERSAL CONTROLLER
 - Software version 2.1 or higher

The software version is displayed in the EasyConnect software, 'Diagnosis', 'Basic Device' line.

A product sticker on the main PCB also carries the software version number (only for version 3 or higher).

With earlier software versions there is no data exchange between the expansion module EM-IP and controller. This means that the network is not able to read out current values from the controller or to send any values.



You need not adapt the controller configuration with the EasyConnect configuration software for the expansion module to work.

2.3 Functions of the Reset push button



Fig. 1: Reset push button

EM-IP has a Reset push button (Fig. 1/1).

Use the Reset push button for the following actions:

2.3.1 Rebooting EM-IP

- ▶ Press the Reset push button (Fig. 1/1) briefly (4 seconds max.).
 - ⇒ The status LED (Fig. 1/2) becomes red for 2 seconds, then the module is rebooted.



During the start phase, the status LED (Fig. 1/2) is orange.

2.3.2 Resetting the default IP address

- ▶ Press the Reset push button (Fig. 1/1) for 5 to 9 seconds (9 seconds max.).
 - ⇒ The status LED (Fig. 1/2) blinks green, and EM-IP is set to the default IP address (169.254.0.1) until the next reboot.

2.3.3 Activating the DHCP server

- ▶ Press the Reset push button (Fig. 1/1) for 10 to 14 seconds (14 seconds max.).
 - ⇒ The status-LED (Fig. 1/2) blinks green/red (alternating) as soon as the DHCP server is activated.

While the DHCP server is active, it waits for requests from a DHCP client in the network and allocates an IP address to each client that sends a request. This function simplifies the connection from a PC to EM-IP.

2.3.4 Restoring the factory settings

- ▶ Keep the Reset push button (Fig. 1/1) pressed for more than 15 seconds.
- ⇒ The status LED (Fig. 1/2) blinks orange.

Once the factory configuration has been set again, the system is rebooted.

Displaying the configuration manual as PDF document

3 Web server settings

3.1 Supported browsers

Browsers for Mac OS X

The following web browsers may be used with Mac OS-X:

- **Safari** version 6.0.5 or higher
- **Google Chrome** version 70.0.xxx or higher
- **Mozilla Firefox** version 60 or higher

Browser with Microsoft Windows

The following web browsers may be used with Microsoft Windows:

- **Microsoft Internet Explorer** version 8 or higher
- **Google Chrome** version 70.0.xxx or higher
- **Mozilla Firefox** version 60 or higher

3.2 Standard IP addresses

i
EM-IP has the following standard IP address:
169.254.0.1/16 (i.e. subnet mask **255.255.0.0**).

The integral DHCP server is not active upon delivery. Use the Reset push button to activate it.

If the connected PC is a DHCP client and if there is no DHCP server, the client should generate its own address within 60 seconds. As a consequence, EM-IP can access the web server even if the network characteristics of the PC are not changed.

3.3 Supported users

Personnel:

- Network administrator

! NOTICE!
Danger of injury or risk of damage to property due to insufficiently qualified individuals!
Only network administrators may enter or change data for the web server ↪ *Chapter 1.6 'Qualified staff' on page 6.*
If unauthorised individuals make changes in the setup menu, the warranty becomes void.

The 'Setup' menu of the web server is password protected to prevent unauthorised individuals from entering or changing data. The Setup menu has been configured for different user groups.

User (group)	Rights	Default password
Guest	Read-only access to 'General settings'	–
User	Can change operating mode default settings and selected parameters for EM-IP	User
Admin	Can change user and admin passwords as well as all other settings including BACnet/IP and Modbus/IP	Admin

! NOTICE!
Change your password!
The password for each user group defaults. The default passwords have to be changed by the network administrator at the time of commissioning ↪ 'Displaying user administration' on page 18.

i
User and Admin cannot access the software at the same time.
When Admin logs on to the web server, any User connection that may be active at that time is terminated.
User will be informed accordingly by a system message.

3.4 Displaying the configuration manual as PDF document

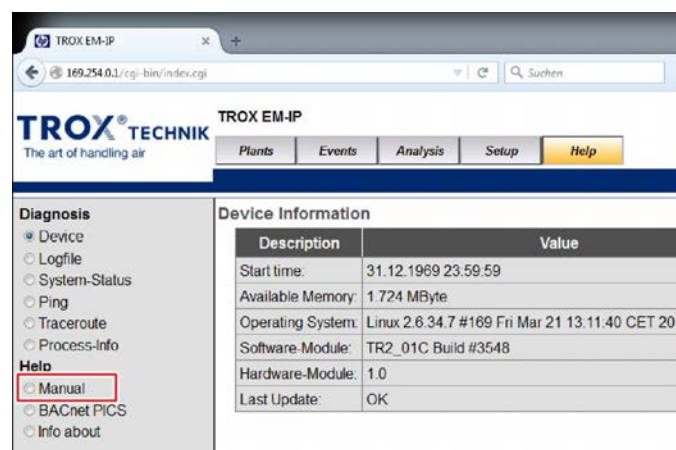

Fig. 2: 'Help' menu

To display the configuration manual for EM-IP, go to the 'Help' menu, then select 'Help/Manual' on the left side ↗ Chapter 3.5.8 'Functions of the 'Help' menu' on page 25.

3.5 Web server navigation

3.5.1 Accessing the web interface

To access the web interface, just enter the IP address of EM-IP (this should work unless you have changed the browser settings).

1. ▶ Connect EM-IP with a network cable to your PC ↗ EM-IP installation manual.



Fig. 3: Browser address field

2. ▶ Enter the IP address of EM-IP into the browser address field ↗ Chapter 3.2 'Standard IP addresses' on page 10.

⇒ The authentication window of the web interface is displayed.



Fig. 4: Accessing the web interface

3. ▶ Log in ↗ Chapter 3.5.2 'Login' on page 11.

3.5.2 Login

You can access the functions of EM-IP only after you have been authenticated.

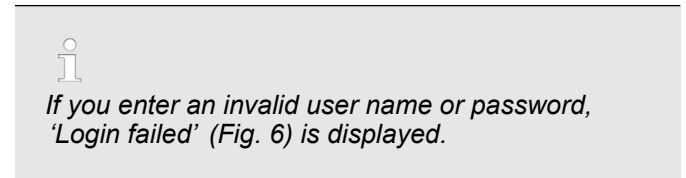

Fig. 5: Login

- ▶ Enter 'User name' and 'Password' (↗ Chapter 3.3 'Supported users' on page 10), then select 'Login'.
- ⇒ The starting screen of the web interface is displayed.



Fig. 6: Login failed



3.5.3 Menu navigation

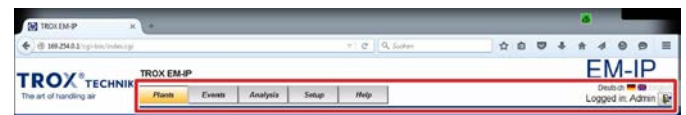
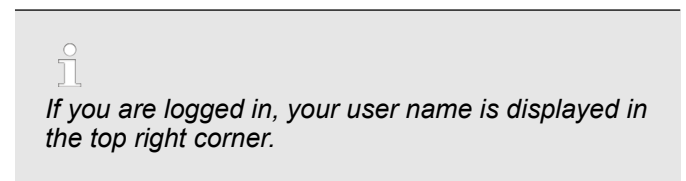

Fig. 7: Menu bar

Use the items in the menu bar (Fig. 7) at the top to navigate to any particular page.



The menu items offer the following options:

Language selection

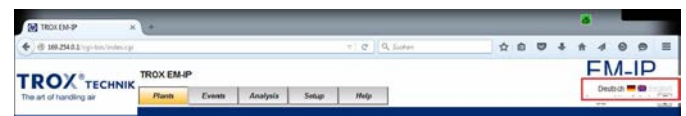

Fig. 8: Language selection for EM-IP

To choose between German and English, select the appropriate flag (Fig. 8).

Login



Fig. 9: Login menu











If you are logged in, your user name is displayed in the top right corner (Fig. 9).

When you select this item and reply to the safety question; any other user who may be logged in is then logged out, and the Login page is displayed for you to log in.

 Chapter 3.5.2 'Login' on page 11

Symbols

The following symbols are used in the menus:

Field	Function
	Add a data source
	Edit a data source (add, delete, change)
	Refresh screen
	Print screen
	Select date
	Close menu
	Save changes
	Close menu/log out/change user
	Set or change system and menu times
	Delete

3.5.4 Functions of the 'Plants' menu Plant

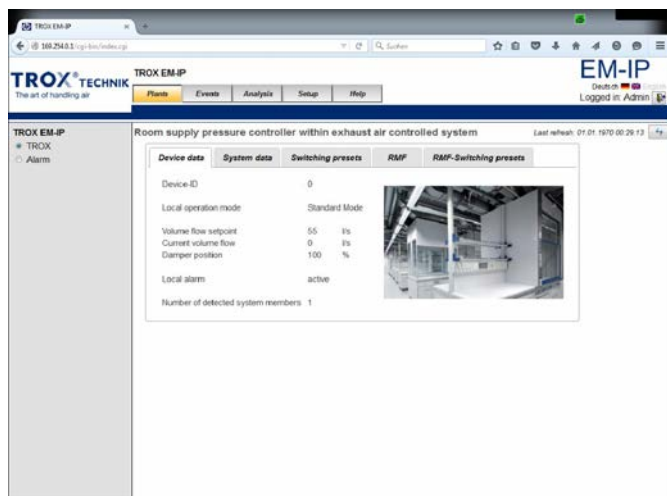



Fig. 10: Plants menu

This is the page which you see after you log in.

A call to the 'Plants' menu item displays the web pages that can be used to access the data points of the respective controller.

The following tabs are available:

- Device data
- System data
- Switching presets
- RMF
- RMF switching presets

 All users can view this menu item.

Users who log in as 'User' or 'Admin' can change data.

Users who log in as 'Guest' can only read data, but not change anything.

This menu allows you to see data points and change setpoint values if you are logged in as User or Admin. The files (HTML pages) and data points you actually see depend on the equipment function.

Device data

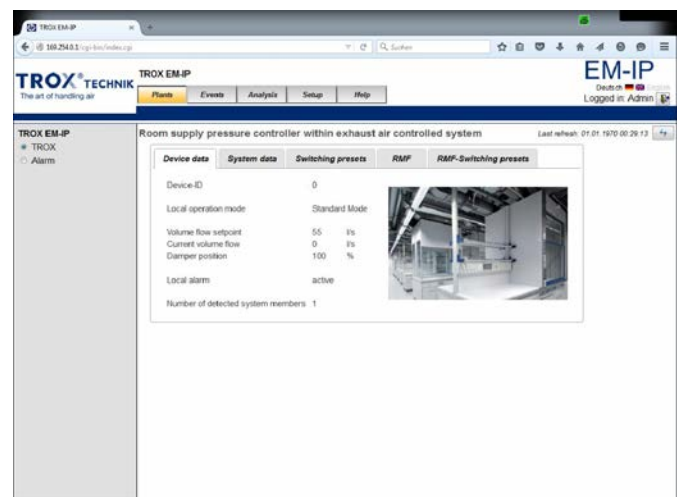

Fig. 11: 'Device data' tab (example)

The 'Device data' tab shows the general device data.

System data

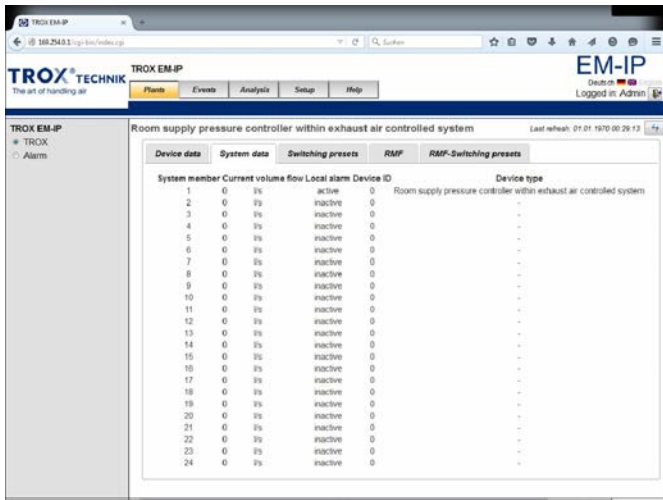

Fig. 12: System data point

The 'System data' tab shows all system members and their parameters and functions.

Switching presets

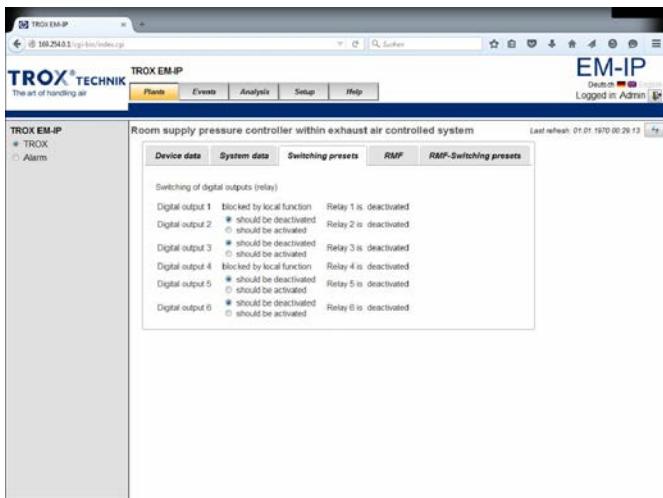

Fig. 13: 'Switching presets' tab (example)

Use the 'Switching presets' tab to define how the unused digital outputs (relays) should respond.

RMF



This tab is available only for room supply and room extract air control.

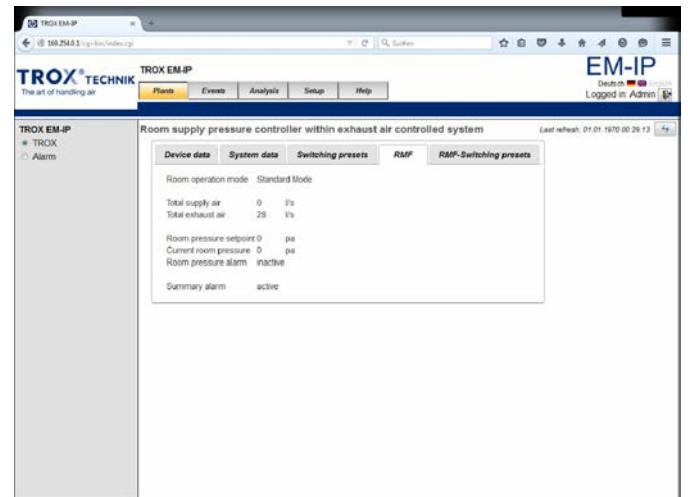

Fig. 14: RMF tab

The 'RMF' tab shows data for the selected room.

RMF switching presets



This tab is available only for room supply and room extract air control.

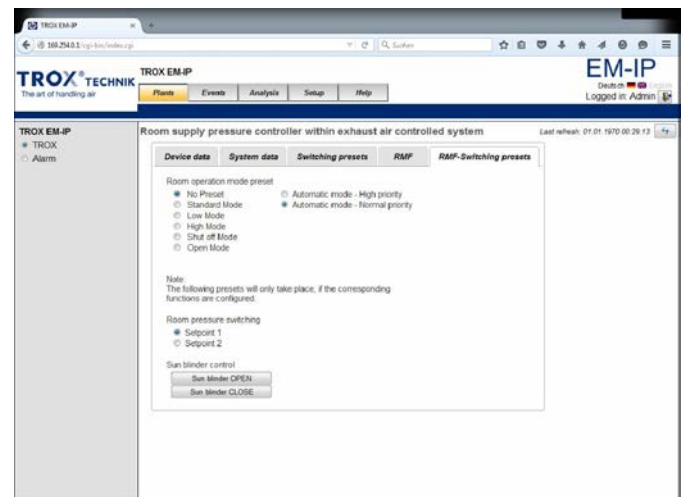

Fig. 15: 'RMF switching presets' tab

Use the 'RMF switching presets' tab to define operating mode default settings, switching between room pressure setpoints and the opening or closing of optional sun blinds.



Switching between room pressure setpoints and controlling the sun blinds is only possible if the respective functions have been configured.

3.5.5 Functions of the 'Events' menu

Events

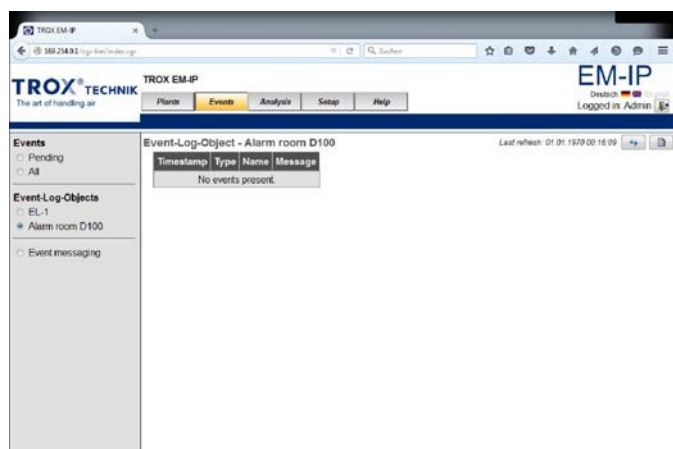

Fig. 16: Events menu

When you select the 'Events' menu, the defined events are displayed.

You need to define/create events for data points (BACnet objects) before they can be displayed
 ↪ Chapter 3.5.7.11.2 'BACnet objects' on page 23.

i
 This menu item can only be accessed by 'Admin'.
 Other users cannot access this menu item.

3.5.6 Functions of the 'Analysis' menu

i
 This menu item can only be accessed by 'Admin'.
 Other users cannot access this menu item.

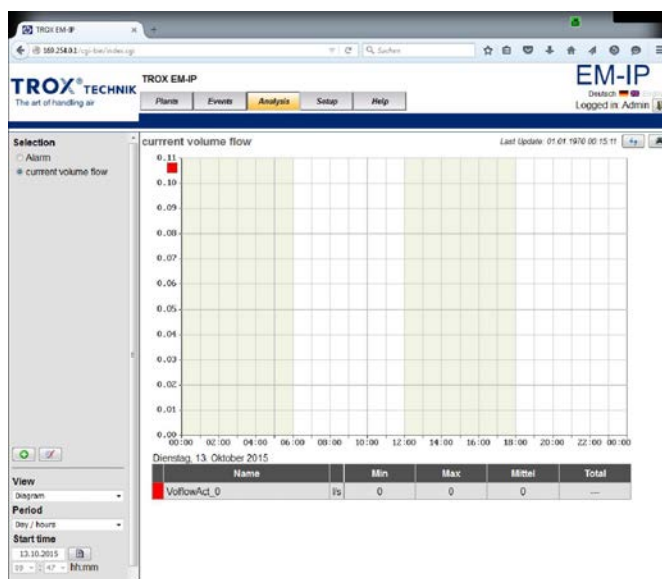

Fig. 17: Analysis menu

When you select the 'Analysis' menu, the defined trend logs are displayed.

You can start an analysis/trend log only after you have created or configured this trend log (BACnet object).

Select 'View' to define whether you want to display the evaluated measured values as diagrams or lists.

Use the selection bar on the left to select data sources (trend log objects). To show and configure more events or analyses, use the Setup menu.

Use 'Period' and 'Start time' to define an evaluation period.

Fields of the 'Analysis' menu

Field	Function
View	Choose how you want to view data (diagram or list).
Period	Use this item to define a period. Choice of: Day / 15 minutes, week, month, quarter, year
Start time	Start time for the evaluation.

i
 Creating a new analysis: ↪ Chapter 3.5.7 'Functions of the 'Setup' menu' on page 15

3.5.7 Functions of the 'Setup' menu

Setup

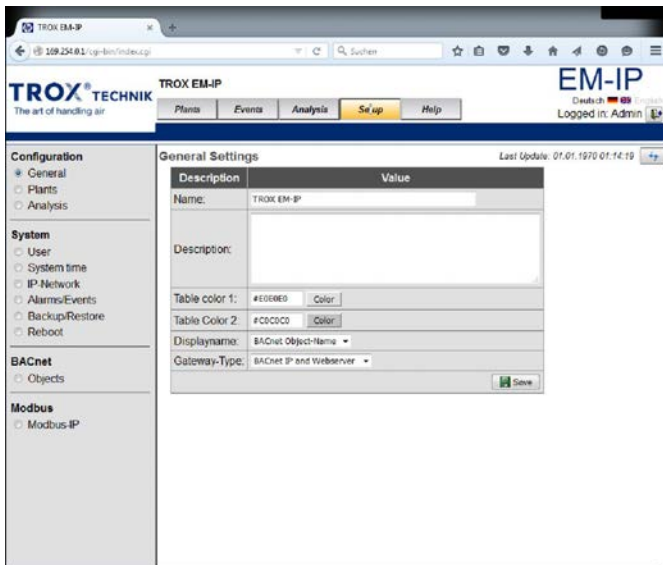

Fig. 18: Setup menu

Select the 'Setup' menu to display the system settings.



You can access functions of the Setup menu only if you are logged in as 'Admin'.

Apart from the 'Change password' item, the functions of this menu can only be changed by 'Admin'.

If you are logged in as 'Guest', you can only read entries, but not change them.

Use 'General settings' in the 'Setup' menu to define general plant/device settings.

Selecting the display name

- ▶ Select the 'Setup' menu from the menu bar.
- ▶ Under 'Configuration', on the left, select 'General'.
 - ⇒ The 'General settings' (Fig. 19) page is displayed.
- ▶ Select 'BACnet description' or 'BACNET object name', as required.



- When you select 'BACnet description', the entries from the Description field (Objects menu) are used for data points.
- When you select 'BACNET object name', the entries from the Object Name field (Objects menu) are used for data points.

- ▶ Use [Save] to confirm and save your entries.

Selecting the 'Gateway type'

- ▶ Select the 'Setup' menu from the menu bar.
- ▶ Under 'Configuration', on the left, select 'General'.
 - ⇒ The 'General settings' (Fig. 19) page is displayed.
- ▶ Select a gateway type: 'Webserver only', 'BACnet/IP and webserver' or 'Modbus/TCP and webserver'.

3.5.7.1 General settings

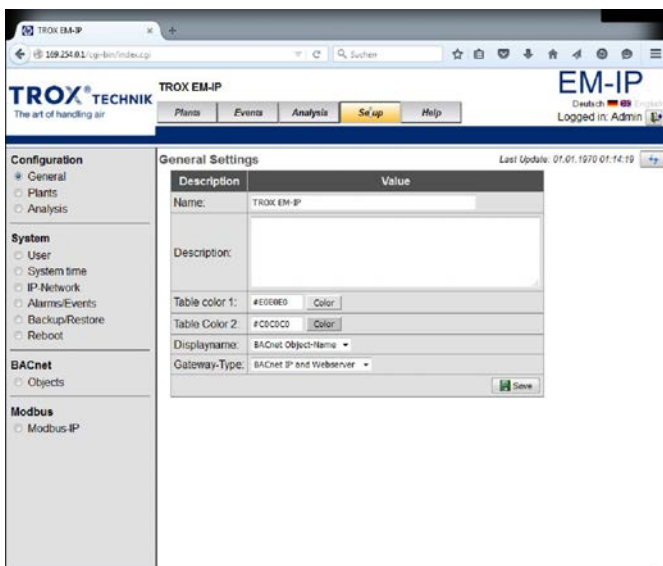

Fig. 19: General settings



Gateway types

- 'Webserver only'
If you select 'Webserver only', only the web interface is available for communication.
This mode is suitable for local operation, i.e. when no values need to be sent via the BACnet or Modbus communication protocol.
- 'BACnet/IP and webserver'
If you select 'BACnet/IP and webserver', the web interface and the BACnet/IP protocol are available.
- 'Modbus/TCP and webserver'
If you select 'Modbus/TCP and webserver', the web interface and the Modbus/IP protocol are available.

- ▶ Use [Save] to confirm and save your entries.

3.5.7.2 Setting up plant views

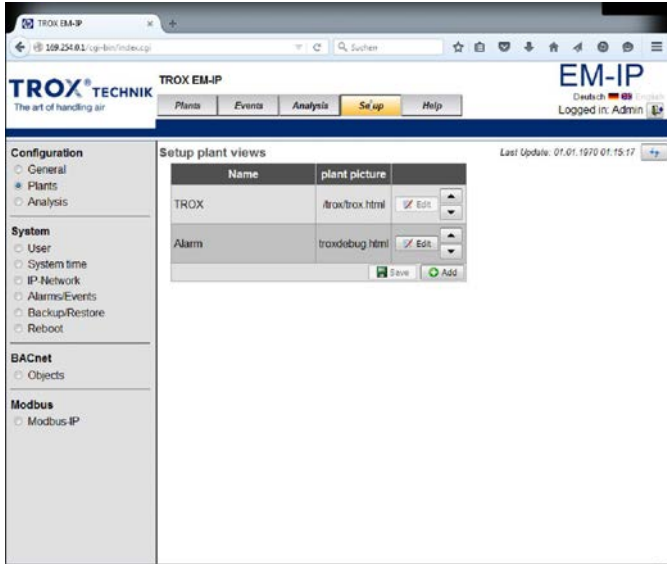

Fig. 20: Setting up plant views

Use the 'Setup plant views' item of the 'Setup' menu to create and save your own pictures of plants.

3.5.7.3 Analysis

Editing an analysis

- ▶ Select the 'Setup' menu from the menu bar.

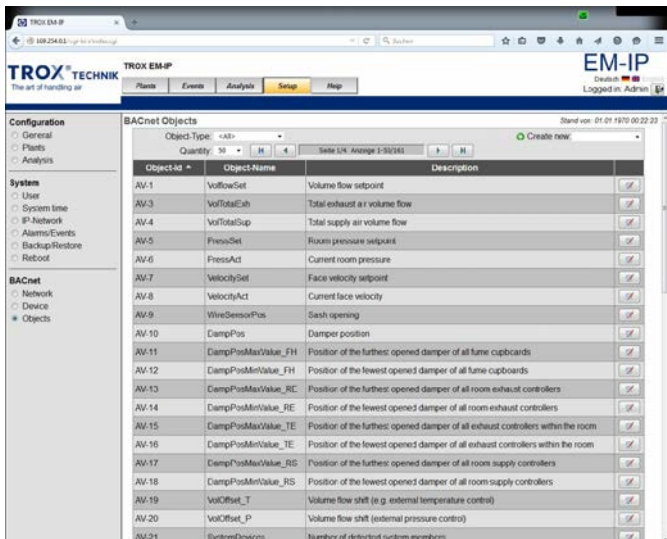

Fig. 21: BACnet objects

- ▶ Under 'BACnet', on the left, select 'Objects'.
⇒ The 'BACnet Objects' menu (Fig. 21) is displayed.
- ▶ Select an object type from the 'Object type' list.

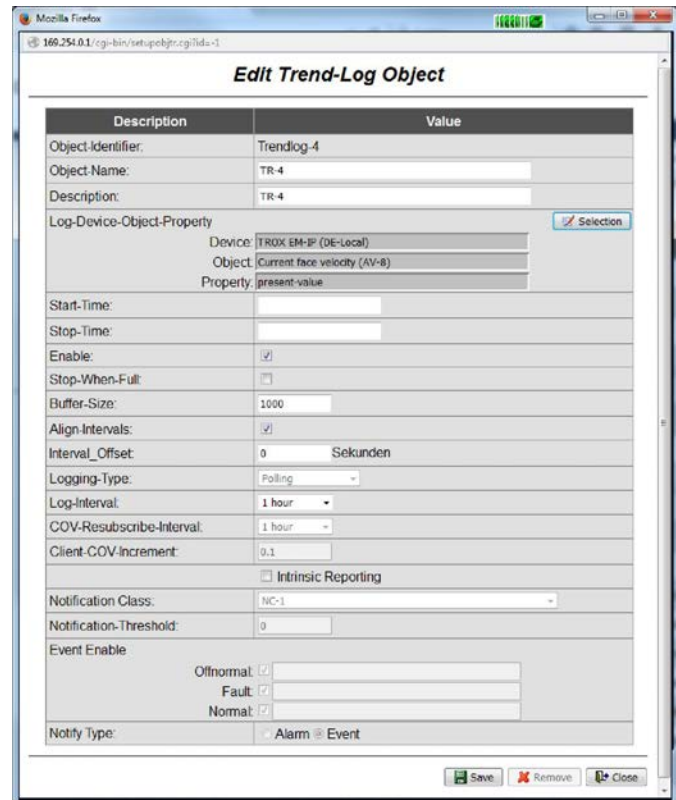

Fig. 22: Editing a trend log object (example)

- ▶ Press for the desired object.
⇒ The 'Edit trend log object' (Fig. 21) menu is displayed for the selected object type.
- ▶ Enter the analysis values into the entry fields.
- ▶ Use [Save] to confirm and save your entries.

Creating a new analysis/trend log

- ▶ Select the 'Setup' menu from the menu bar.
- ▶ Under 'BACnet', on the left, select 'Objects'.
⇒ The 'BACnet objects' (Fig. 21) for the selected object type are displayed.

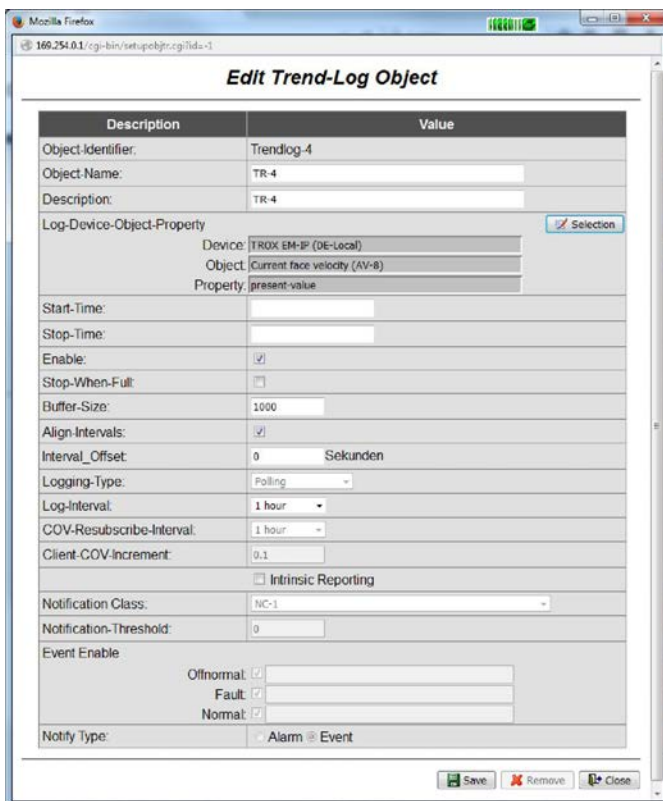

Fig. 23: Editing a trend log object

3. ▶ Select  [Add].
⇒ The 'Edit trend log object' page is displayed.

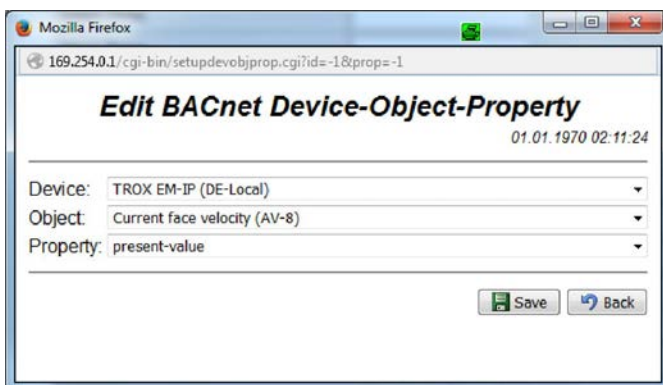





Fig. 24: Editing BACnet Device-Object-Property

4. ▶ Select  [Selection] in the 'Log-Device-Object-Property' line.
⇒ The 'Edit BACnet Device-Object-Property' (Fig. 24) is displayed.
5. ▶ Enter the new values.
6. ▶ Use  'Save' to save your entries.
7. ▶ Select  'Back' to close the [Edit BACnet Device-Objekt-Property] screen.

Setting up an analysis

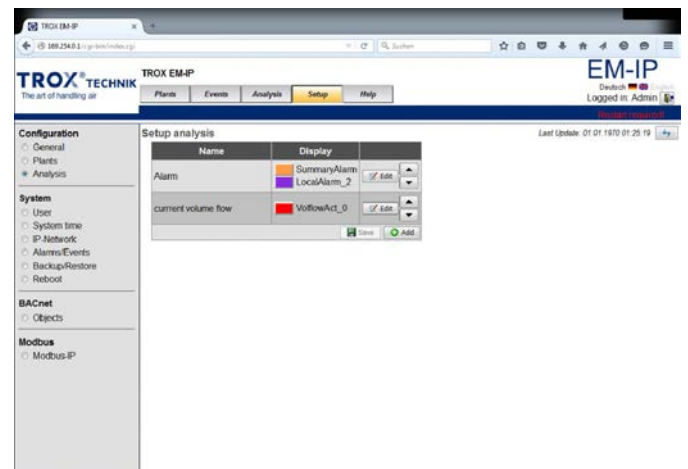



Fig. 25: Setting up an analysis

Select 'Analysis' from the 'Setup' menu to display 'Setup analysis' and create a new analysis or change an existing analysis.

Displaying 'Setup'

1. ▶ Select the 'Setup' menu from the menu bar.
2. ▶ Under 'Configuration', on the left, select 'Analysis'.
⇒ The 'Setup analysis' (Fig. 25) page is displayed.
3. ▶ Select  [Add].
⇒ A window opens where you can select a trend log object.
4. ▶ Select a trend log object.

Viewing an analysis

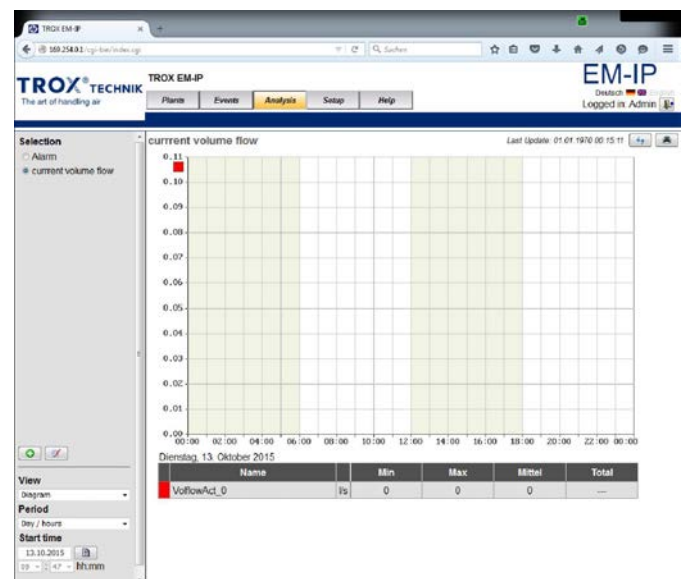

Fig. 26: Viewing an analysis

The 'Selection' item of the 'Analysis' menu allows you to view the new analysis.

Viewing an analysis

- ▶ Select the 'Analysis' menu from the menu bar.
- ▶ Go to 'Selection', on the left, and select an analysis.
 - ⇒ The analysis is displayed.

3.5.7.4 User administration

The 'User administration' item of the 'Setup' menu allows you to change access rights and passwords.

Displaying user administration

- ▶ Select the 'Setup' menu from the menu bar.

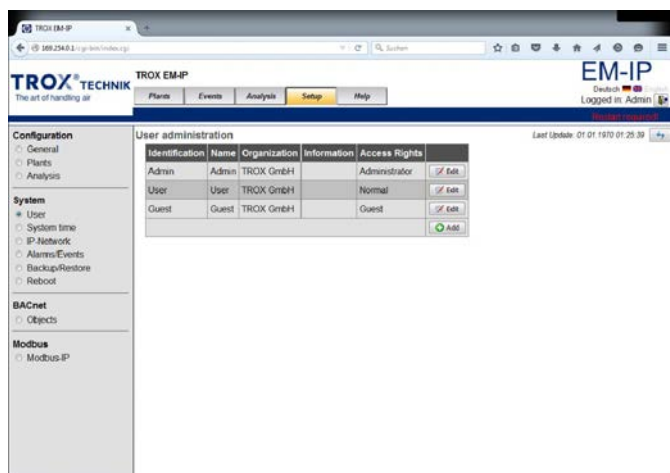

Fig. 27: User administration

- ▶ Under 'System', on the left, select 'User'.
 - ⇒ The 'User administration' (Fig. 27) page is displayed.
- ▶ Select [Edit] for the user you want to change.
 - ⇒ The Login screen is displayed.

When you select this menu item, a web-page is displayed on which you can enter a new user or change data for an existing user, including the password.

4. ▶ **! NOTICE!**
Risk of damage to property due to unauthorized access to passwords or user profiles.

Enter password.

If you are logged in as Admin, you may change both your own Admin password and passwords for User.

Changing passwords

- ▶ Change the user profile.
- ▶ Use [Save] to confirm and save your entries.

3.5.7.5 Setting the system time

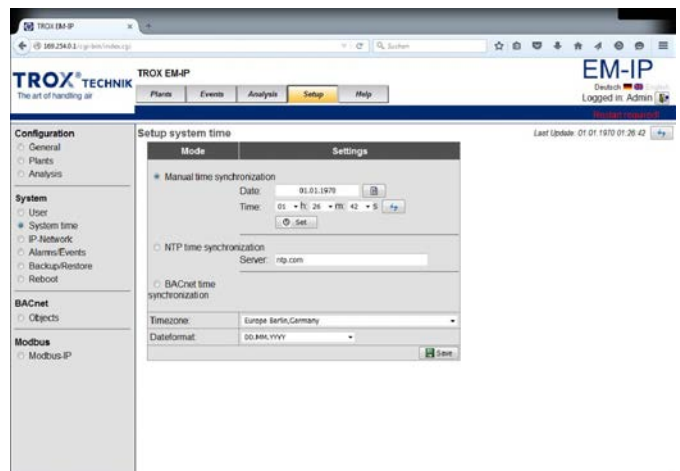

Fig. 28: Setting the system time

If you want to use the Alarming, Trending, Scheduling or Eventlog function, you need to set a system time for EM-IP.

If you select 'Manual time synchronisation' and the power fails, the time will be maintained only if the optional RTC module has been installed.

Setting the time manually

Setting the system time/date manually

- ▶ Select the 'Setup' menu from the menu bar.
- ▶ Under 'System', on the left, select 'System time'.
 - ⇒ The 'Setup system time' (Fig. 28) page opens.
- ▶ Go to 'Time zone' and select a time zone.
- ▶ Go to 'Date format' and select a date format.
- ▶ Enter the current date (use the number pad) into the 'Date' field, then press [Enter] to confirm your entry.

- ▶ Enter the current time (use the number pad) into the 'Time: h, m, s' fields, then press [Enter] to confirm your entries.

NTP time synchronisation

'NTP time synchronisation' allows you to receive time messages from external NTP servers in the IT network.

Enter the IP address of the NTP server.

Time synchronisation messages set the local clock to the correct time.

 The optional Real Time Clock (RTC) is not required in this case.

BACnet time synchronisation

Time synchronisation via BACnet requires a BACnet time server in the network.

Scheduling

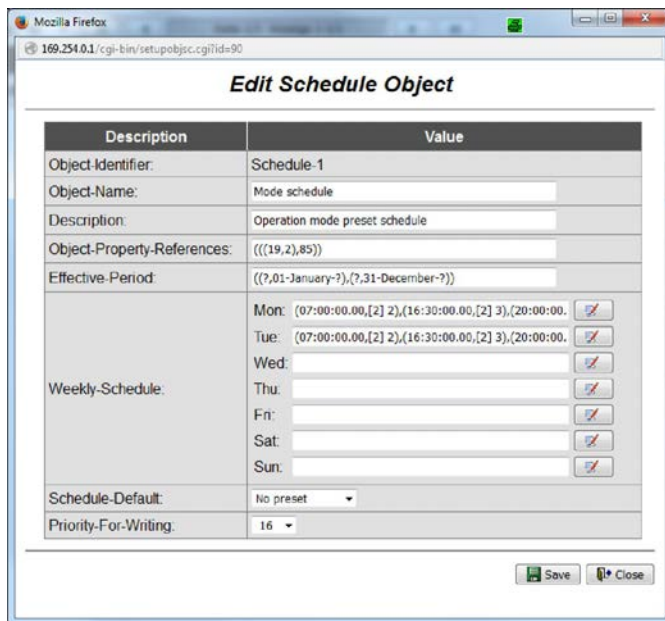



Fig. 29: Editing a schedule object

- ▶ Go to the 'Setup system time' (Fig. 28) page and select  'Set'.
⇒ The 'Edit schedule object' (Fig. 29) page opens.

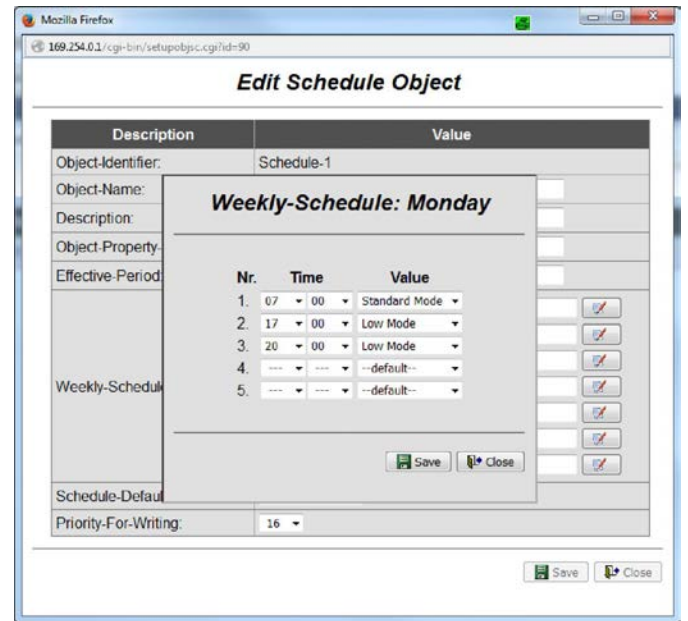







Fig. 30: Weekly schedule: [day of the week]

- ▶ Go to 'Name' / 'Weekly schedule' and use  to select a day of the week.
⇒ The 'Weekly schedule: [day of the week]' (Fig. 30) page is displayed.
- ▶ Enter 'Time' and 'Value'.
- ▶ Use  to confirm and save your entries; use  to close the page.
- ▶ Make entries for other days of the week as described above.
- ▶ After you have completed your entries on the 'Edit schedule object' page, use  'Save' to save your entries, then use  'Close' to close the page.

3.5.7.6 IP network

This dialogue allows you to set or change network properties. If you change network properties, you may have to change the PC settings also.

The Switch function allows you to deactivate the integral network switch.

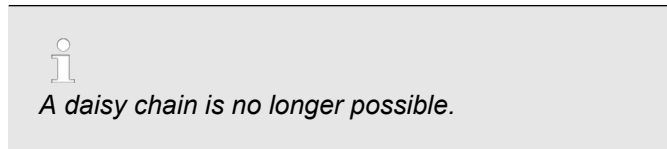

To activate web communication using the safe HTTPS protocol, select 'HTTPS'.

IP network settings

1. ▶ Select the 'Setup' menu from the menu bar.

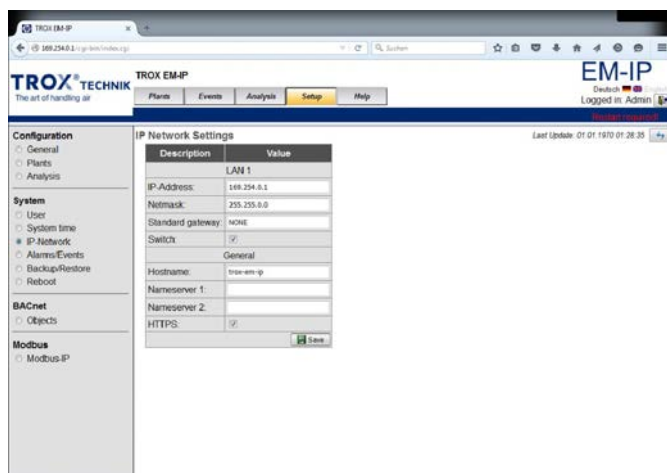

Fig. 31: IP network settings

2. ▶ Under 'System', on the left, select 'IP network'.
⇒ The 'IP network settings' (Fig. 31) page is displayed.
3. ▶ Enter the relevant data.
4. ▶ Use 'Save' to save your entries.

3.5.7.7 Alarm management

This dialogue allows you to enter an SMTP server and access data such that e-mails for events that you have previously created in the 'Objects' area can be sent.

Opening the 'Alarm management' page

1. ▶ Select the 'Setup' menu from the menu bar.

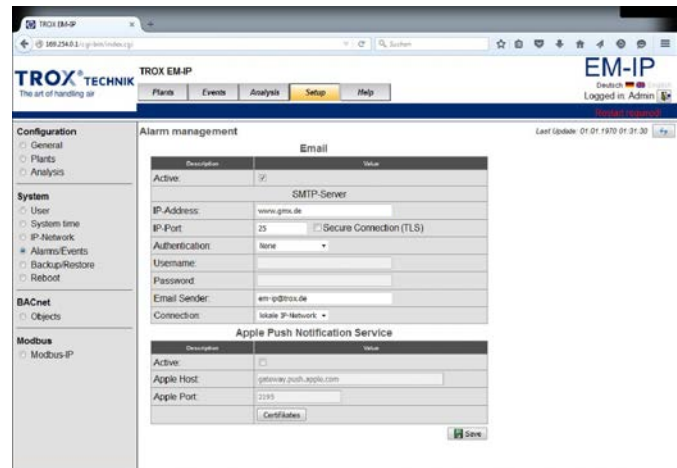

Fig. 32: Alarm management

2. ▶ Under 'System', on the left, select 'Alarms/ Events'.
⇒ The 'Alarm management' (Fig. 32) page is displayed.
3. ▶ Enter the relevant data.
4. ▶ Use 'Save' to save your entries.

3.5.7.8 Backup

The 'Backup' function allows you to save all the settings you have made for EM-IP to a file; the 'Restore' function allows you to restore data.

This page also allows you to update the operating system software.

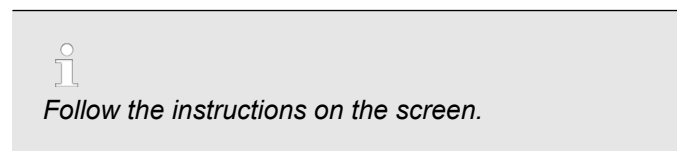

Backup

1. ▶ Select the 'Setup' menu from the menu bar.

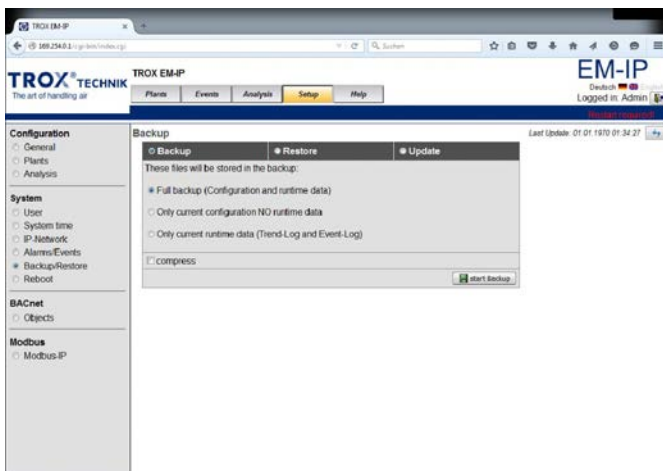

Fig. 33: Backup

2. ▶ Under 'System', on the left, select 'Backup'.
⇒ The 'Backup' (Fig. 33) page opens.
3. ▶ Select 'Backup' on the 'Backup' page.
4. ▶ Activate the desired option.
5. ▶ Select 'Compress', if necessary.
6. ▶ Use 'Start backup' to start the backup process.

Restoring data

1. ▶ Select the 'Setup' menu from the menu bar.

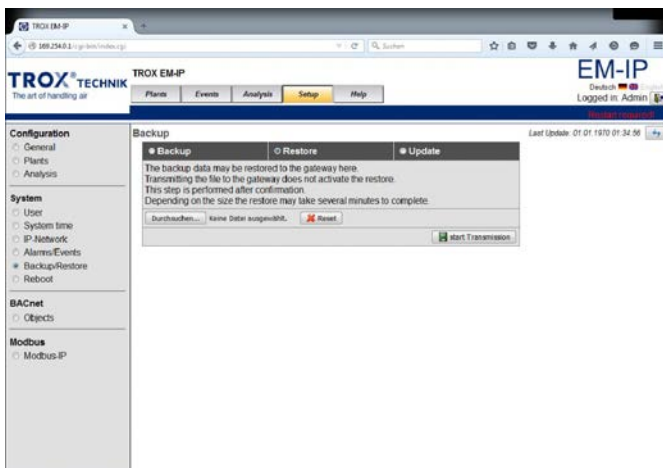

Fig. 34: Backup/Restore

2. ▶ Under 'System', on the left, select 'Backup'.
⇒ The 'Backup' (Fig. 33) page opens.
3. ▶ Select 'Restore' on the 'Backup' page.
4. ▶ Follow the instructions on the screen.

Select 'Search', then select the file to be restored from the respective directory.

5. ▶ Use 'Start transmission' to start the restoring process.

Loading an update

1. ▶ Select the 'Setup' menu from the menu bar.

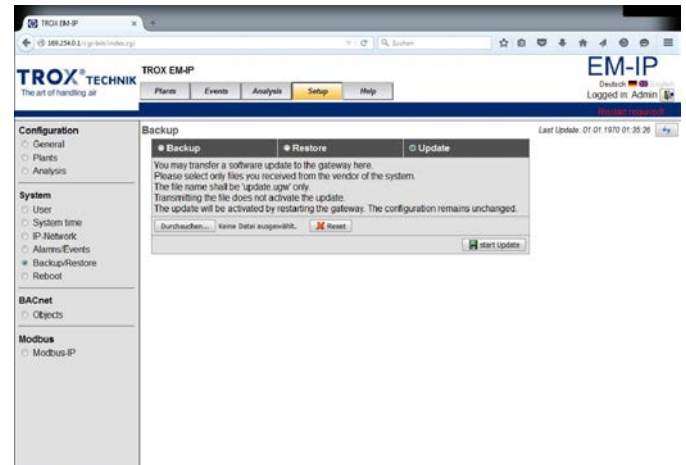

Fig. 35: Backup/Update

2. ▶ Under 'System', on the left, select 'Backup'.
⇒ The 'Backup' (Fig. 33) page opens.
3. ▶ Select 'Update' on the 'Backup' page.
4. ▶ Follow the instructions on the screen.

Use 'Search', then select software update from the respective directory.

5. ▶ Use 'Start update' to start the update process.

3.5.7.9 Reboot

A new configuration is only installed if you have selected 'Activate configuration'. Otherwise the current configuration remains unchanged. When you carry out a complete system reboot, the unit is completely rebooted. The effect is the same as with switching it off and on again.

After about 80 s the system is active again. You have to log in again.

When you select 'Reboot', EM-IP is immediately rebooted. After a reboot no data will be transferred for about 80 s.

Reboot

1. Select the 'Setup' menu from the menu bar.

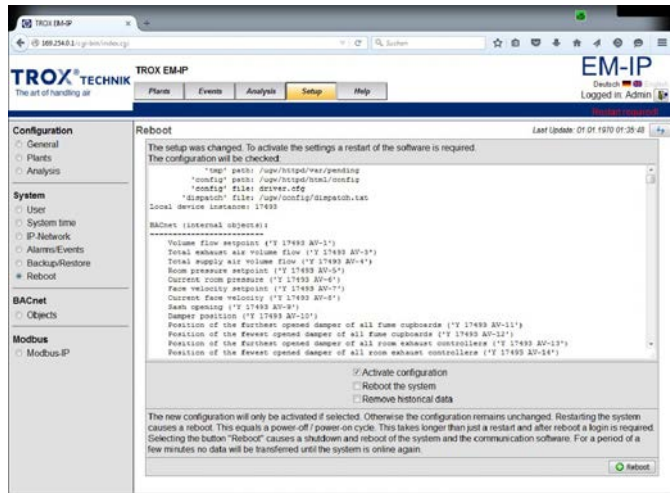

Fig. 36: Reboot

2. Under 'System', on the left, select 'Reboot'.
⇒ The 'Reboot' (Fig. 33) menu is displayed.
3. Select 'Activate configuration'.
- 4.

Follow the instructions on the screen.

Use the 'Reboot' button to start the reboot process.

3.5.7.10 Modbus/IP

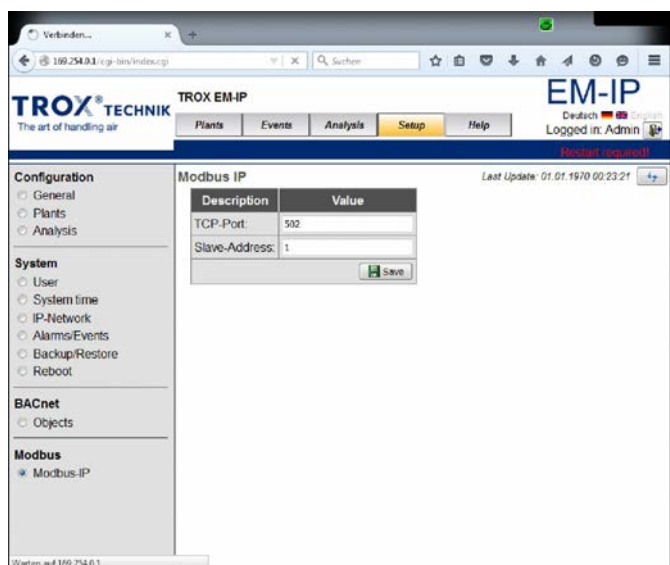

Fig. 37: Modbus/IP

The 'Modbus/IP' dialogue allows you to set slave addresses and the TCP port.

TCP port

Enter the TCP port to be used for Modbus into the [TCP-Port] field.

The default value is 502.

Slave address

Enter the Modbus slave address for EM-IP into the [Slave address] field.

The default value is 1.

Enter settings

1. Select the 'Setup' menu from the menu bar.
2. Under 'Modbus', on the left, select 'Modbus/IP'.
⇒ The 'Modbus/IP' (Fig. 37) menu is displayed.
3. Enter the new values.
4. Use [Save] to save your entries.

3.5.7.11 Editing a BACnet/IP configuration

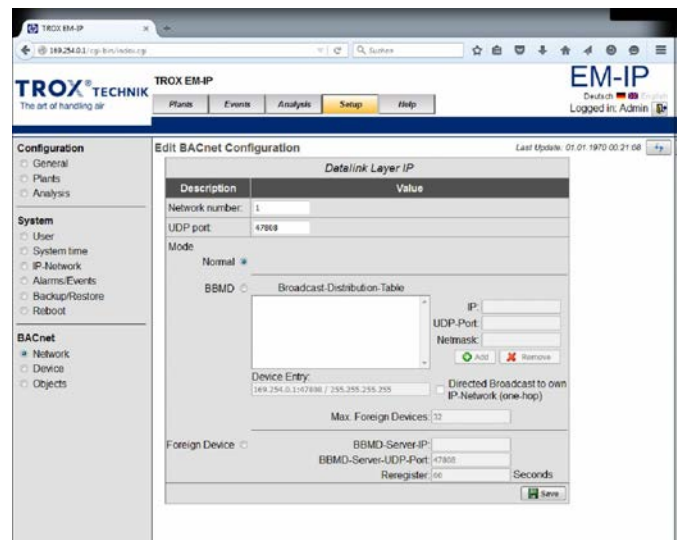

Fig. 38: Editing a BACnet/IP configuration

The 'Edit BACnet/IP configuration' allows you to set the properties for a BACnet device object.

Network number

Enter the network number into the [Network number] field.

UDP port

Enter the UDP port to be used for BACnet into the [UDP port] field.

The default value is 47808 (or 0xBAC0 as a hexadecimal value).

Operating mode

Use this field to enter the operating mode.

- Normal
- BBMD
- Foreign Device (FD)

The default is 'Normal'.

! NOTICE!
Using BBMD and Foreign Device (FD) incorrectly may result in serious network problems (broadcast).

Only use these settings for networks where IT routers block broadcast messages.

Editing a configuration

1. ▶ Select the 'Setup' menu from the menu bar.
2. ▶ Under 'BACnet', on the left, select 'Network'.
⇒ The 'Network' (Fig. 38) menu is displayed.
3. ▶ Enter new values or change option fields as required.
4. ▶ Use [Save] to save your entries.

3.5.7.11.1 Editing a device object

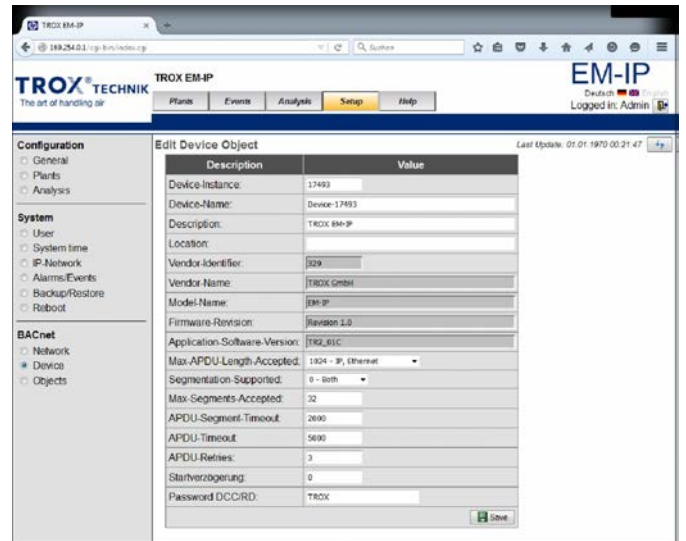

Fig. 39: Editing a device object

This menu allows you to enter device-specific BACnet settings.

Editing device object properties

1. ▶ Select the 'Setup' menu from the menu bar.
2. ▶ Under 'BACnet', on the left, select 'Device'.
⇒ The 'Device' (Fig. 39) page opens.
3. ▶ Enter new values or change option fields as required.
4. ▶ Use [Save] to save your entries.

3.5.7.11.2 BACnet objects

The 'BACnet objects' page allows you to edit existing data points.

This includes

- Intrinsic reporting
- Creating trend logs
- Events and alarm notification
- Scheduler

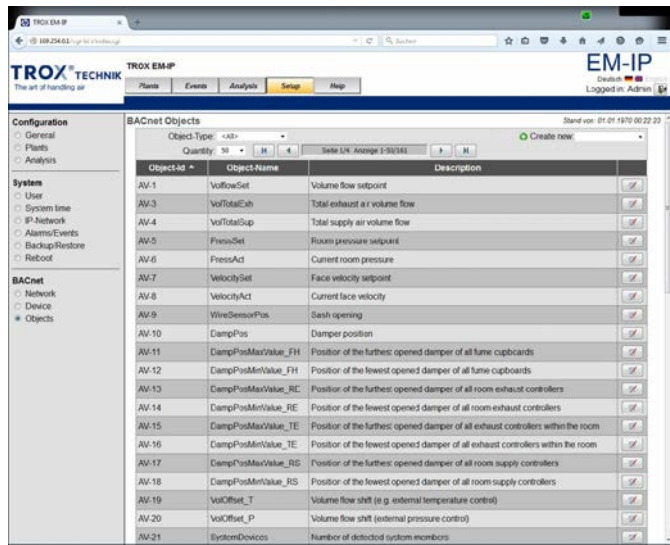

Fig. 40: BACnet objects

The 'BACnet objects' page allows you to edit the properties of a BACnet device object.

Editing device object properties

- ▶ Select the 'Setup' menu from the menu bar.
- ▶ Under 'BACnet', on the left, select 'Objects'.
 - ⇒ The 'BACnet objects' (Fig. 40) menu is displayed.

Editing a trend log object

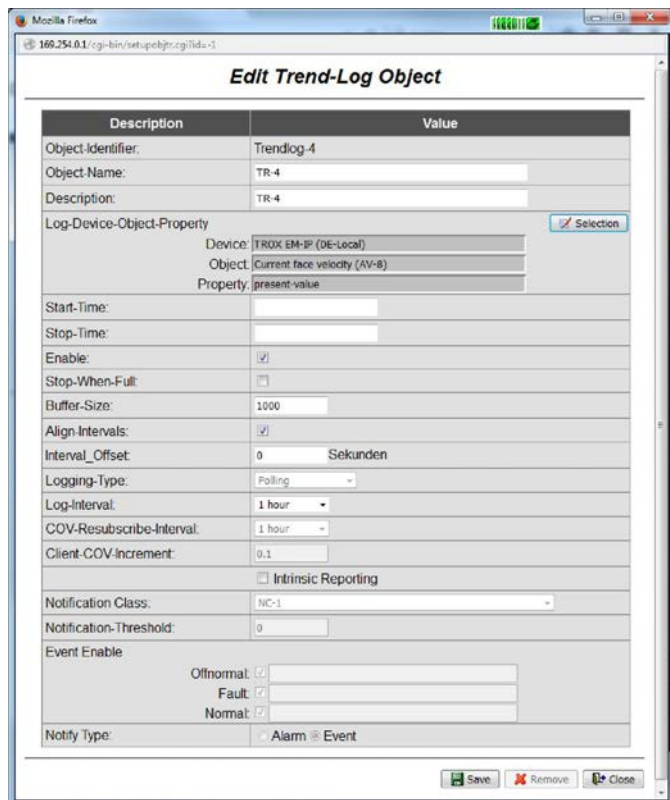

Fig. 41: Editing a trend log object

- ▶ Use to select the object you want to edit.
 - ⇒ The 'Edit trend log object' page is displayed.

- ▶ Enter new values or change option fields as required.
- ▶ Use 'Save' to save your entries.

Editing an event log

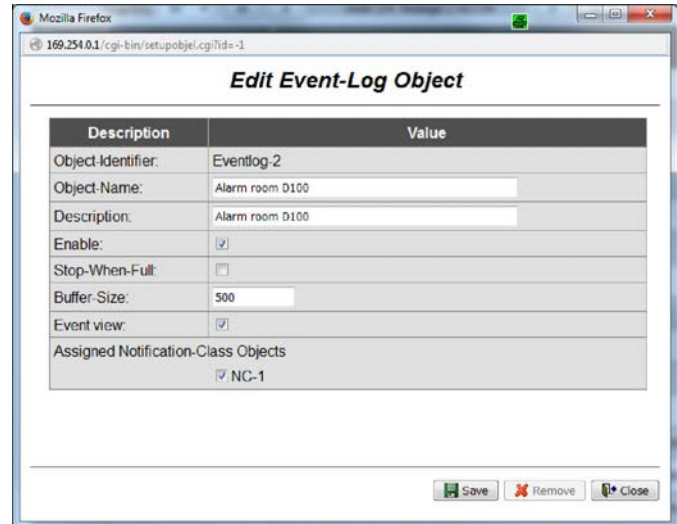

Fig. 42: Editing an event log object

- ▶ Go to 'Setup system time' (Fig. 28) and select .
 - ⇒ The 'Edit event log object' (Fig. 42) menu is displayed.
- ▶ Enter the relevant data.
- ▶ Use [Save] to save your entries, and [Close] to close the menu.

Creating/editing event and alarm notifications

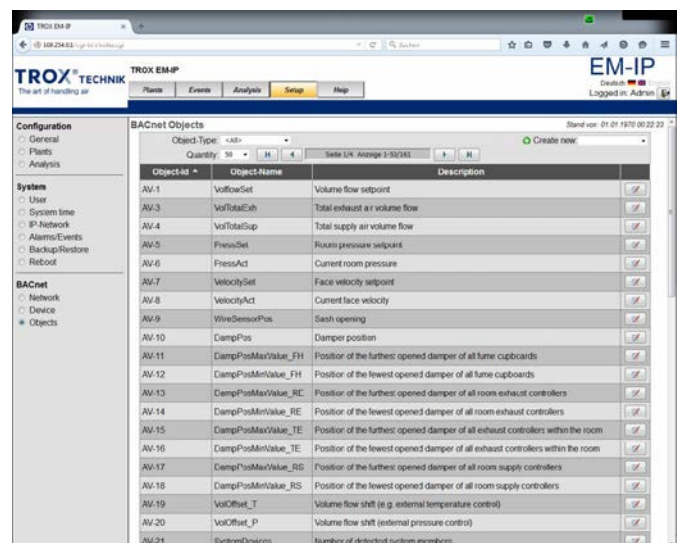



Fig. 43: BACnet objects

- ▶ Select the 'Setup' menu from the menu bar.

2. ▶ Under 'BACnet', on the left, select 'Objects'.
 - ⇒ The 'BACnet objects' (Fig. 43) menu is displayed.

Creating

1. ▶ Use  [Create new] to select an object type.

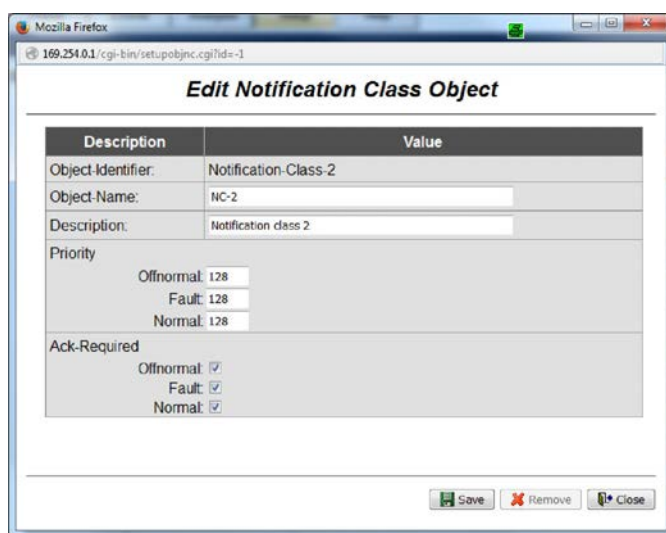

You may create the following new object types:

 - Notification class
 - Event log
 - Trend log
 - ⇒ The respective page (Fig. 44) is displayed.



Description	Value
Object-Identifier:	Notification-Class-2
Object-Name:	NC-2
Description:	Notification class 2
Priority	
Offnormal:	128
Fault:	128
Normal:	128
Ack-Required	
Offnormal:	<input checked="" type="checkbox"/>
Fault:	<input checked="" type="checkbox"/>
Normal:	<input checked="" type="checkbox"/>



Fig. 44: Editing a notification class object (example)

2. ▶ Enter the relevant data.
3. ▶ Use  [Save] to save your entries, and  [Close] to close the menu.

Editing

1. ▶ Use  to select the object you want to edit.

You may select the following object types:

 - Analog value
 - Binary value
 - Multistate value
 - ⇒ The respective page is displayed.
2. ▶ Enter the relevant data.
3. ▶ Use  [Save] to save your entries, and  [Close] to close the menu.

3.5.8 Functions of the 'Help' menu

When you select the 'Help' menu item, a page is displayed from which you can access help files.

If you are logged in as 'User' or 'Admin', you may also upload your own files.

Displaying help

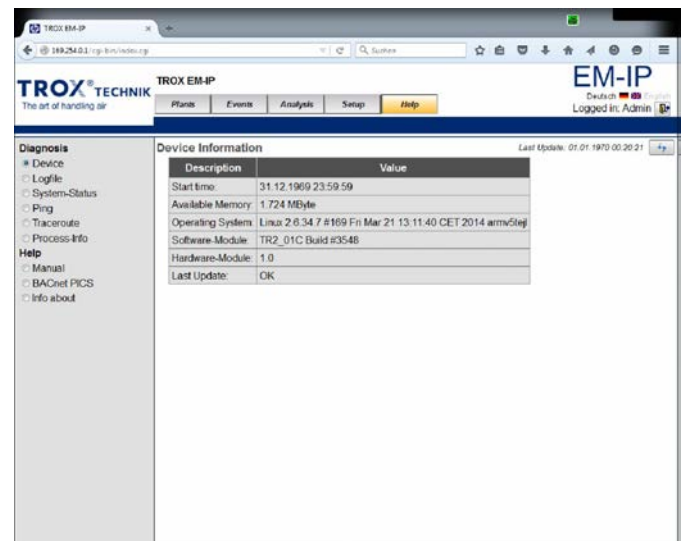

Fig. 45: Help (example)

- ▶ Select the 'Help' menu from the menu bar.
 - ⇒ The 'Help' menu (Fig. 45) is displayed.



On the left of the screen you may select information on diagnosis, the user's manual and BACnet PICS as PDF.

4 Interface information

4.1 BACnet interface

Application

The expansion module EM-IP supports the following BACnet interface functions in the BACnet-IP protocol settings:

- Native BACnet, i.e. the BACnet interface is implemented on the field module (EASYLAB volume flow controller)
- External hardware components such as physical gateways are not required
- BACnet interface documentation includes the following documents: Protocol Implementation Conformance Statement (PICS), BACnet Interoperability Building Blocks Supported (BIBBS), as well as a description of the device object and the supported objects

Abbreviations

EASYLAB:

- FH - Fume cupboard controller
- RR - Room controller for supply air or extract air (RS, RE, PC)
- RR RMF - Room controller with active room management function
- EC, SC - Single controller for supply air or extract air (EC, SC)

- TAM - Adapter module
- TAM RMF - Adapter module with active room management function
- WR - Defaults for the volume flow controller or room, from the central BMS
- RD - Data provided by the volume flow controller or room

TROX UNIVERSAL CONTROLLER:

- RS/RE - Volume flow controllers for supply or extract air
- RS/RE RMF - Volume flow controller with active room management function
- PR*/PD* - Room pressure controller or duct for supply or extract air
- PR*/PD* RMF - Room pressure controller or duct with active room management function



See also the PICS list for EM-IP under 'Help' in the web server ↗ Chapter 3.5.8 'Functions of the 'Help' menu' on page 25.

BACnet PICS (extract)

Category	Data
Date	2011-07-20
Vendor name/Vendor identifier	TROX GmbH/329
Product name/Model no.	EM-IP/EM-IP
Application/Firmware Revision	2.0
BACnet Protocol Revision	12
Standardized Device Profile	BACnet Application Specific Controller (B-ASC)
Interoperability Building Blocks Supported	DS-RP-B, DS-WP-B, DS-RPM-B, DS-WPM-B, DS-COVU-B, AE-NI- B, AE-ACK-B, AE-ASUM-B, AE-ESUM-B, AE-INFO-B, AE-EL-I-B, SCHEDWS-I-B, T-VMT-I-B, T-ATR-B, DM-DDB-A, DM-DDB-B, DM-DOB_B, DM-DCC-B, DM-TS-B, DMUTC- B, DM-RD-B, DM-LM-B, DM-R-B
Segmentation Capability	No
Data Link Layer Options	TCP-IP 10/100 Mbit
Device Address Binding	No
Network Security Options	No
Character Sets Supported	ISO 10646 (UTF-8)

BACnet interface

DeviceObject

Property	Value	Access
Object identifier	Device instance; default = 17493	WR, RD; E
Device name	Default = "Device17493"; project-specific description can be entered, 62 characters max.	WR, RD; E
Object type	Device (8)	RD
System_Status	OPERATIONAL (0)	RD
Vendor_Name	TROX GmbH	RD
Vendor_Identifier	329	RD
Model_Name	EM-IP	RD
Description	Default = "TROX EM-IP"; description can be entered, 126 characters max.	WR, RD; E
Location	Default = ""; description can be entered, 62 characters max.	WR, RD; E
Firmware_Revision	V2.0	RD
Application_Software_Version	TR2_02E	RD
Protocol_Version	1	RD
Protocol_Revision	12	RD
Protocol Services Supported	Who-is, Who-has, Read-Property, Write-Property, Device-communication-control, Reinitialize-device	RD
Protocol_Object_Types_Supported	DEVICE, ANALOG_VALUE, BINARY_VALUE, MULTI-STATE_VALUE	RD
Object_List	EASYLAB: device, analog-value 1...31, binary-value 1...30, multistate-value 1...8	RD
Max_ADPU_Length_Accepted	1024	RD
Segmentation_Supported	NO_SEGMENTATION (3)	RD
APDU_Timeout	5000	RD
Number_Of_APDU_Retries	3	RD
Device_Address_Binding	–	RD
Database_Revision	0	RD

Access rights:

RD: Read

WR: Write

E: Save in EEPROM

Multistate Value Objects

In-stance	Description	Unit										Access	Support COV
		TCU3				TAM		TROX UNIVERSAL					
		Available with equipment function											
		FH	RR	RR RMF	EC, SC	TAM	TAM RMF	RS/RE	RS/RE RMF	PR*/PD*	PR*/PD* RMF		
MV-2	Mode	x ¹		x			x		x		x	WR, RD	N
MV-3	ModeAct	x	x	x	x				x		x	RD	Y
MV-4	RoomModeAct	x		x			x	x	x	x	x	RD	Y
MV-5	SwitchPos	x										RD	Y
MV-6	Sunblind	x		x			x		x		x	WR, RD	N
MV-7	SC_SetLockHigh-Prio	Not used											
MV-8	SC_GetLockHigh-Prio	Not used											
MV-9	SC_SetPos	Not used											
MV-10	SC_GetPos	Not used											
MV-11	DampPosMax-State_FH	x	x	x	x	x	x					RD	Y
MV-12	DampPosMin-State_FH	x	x	x	x	x	x					RD	Y
MV-13	DampPosMax-State_RE	x	x	x	x	x	x					RD	Y
MV-14	DampPosMin-State_RE	x	x	x	x	x	x					RD	Y
MV-15	DampPosMax-State_TE	x	x	x	x	x	x					RD	Y
MV-16	DampPosMin-State_TE	x	x	x	x	x	x					RD	Y
MV-17	DampPosMax-State_RS	x	x	x	x	x	x					RD	Y
MV-18	DampPosMin-State_RS	x	x	x	x	x	x					RD	Y
MV-26	DampPosMax-State_EC	x	x	x	x	x	x					RD	Y
MV-27	DampPosMin-State_EC	x	x	x	x	x	x					RD	Y
MV-28	DampPosMax-State_SC	x	x	x	x	x	x					RD	Y
MV-29	DampPosMin-State_SC	x	x	x	x	x	x					RD	Y
MV-30	DampPosMax-State_TS	x	x	x	x	x	x					RD	Y

Abbreviations ↪ 'Abbreviations' on page 26

BACnet interface

In-stance	Description	Unit										Access	Support COV
		TCU3				TAM		TROX UNIVERSAL					
		Available with equipment function											
		FH	RR	RR RMF	EC, SC	TAM	TAM RMF	RS/RE	RS/RE RMF	PR*/PD*	PR*/PD* RMF		
MV-31	DampPosMin-State_TS	x	x	x	x	x	x					RD	Y
MV-32	DampPosMax-State_VE							x	x	x	x	RD	Y
MV-33	DampPosMin-State_VE							x	x	x	x	RD	Y
MV-34	DampPosMax-State_VS							x	x	x	x	RD	Y
MV-35	DampPosMin-State_VS							x	x	x	x	RD	Y
MV-36	DampPosMax-State_PKE							x	x	x	x	RD	Y
MV-37	DampPosMin-State_PKE							x	x	x	x	RD	Y
MV-38	DampPosMax-State_PKS							x	x	x	x	RD	Y
MV-39	DampPosMin-State_PKS							x	x	x	x	RD	Y

Abbreviations ↪ 'Abbreviations' on page 26

Analogue Value Objects

In-stance	Description	Unit	Unit										Access	Support COV	
			TCU3				TAM		TROX UNIVERSAL						
			Available with equipment function												
			FH	RR	RR RMF	EC, SC	TAM	TAM RMF	RS/RE	RS/RE RMF	PR*/PD*	PR*/PD* RMF			
AV-1	VolflowSet	l/s (87)	x	x	x	x				x	x			RD	Y
AV-2	VolflowAct	l/s (87)	x	x	x	x				x	x	x	x	RD	Y
AV-3	VolTotalExh	l/s (87)	x	x	x	x	x	x	x	x	x	x	x	RD	Y
AV-4	VolTotalSup	l/s (87)	x	x	x	x	x	x	x	x	x	x	x	RD	Y
AV-5	PressSet	pa (53)			x				x			x	x	RD	Y
AV-6	PressAct	pa (53)			x				x			x	x	RD	Y
AV-7	VelocitySet	m/s (74)	x											RD	Y
AV-8	VelocityAct	m/s (74)	x											RD	Y
AV-9	WireSensorPos	% (98)	x											RD	Y
AV-10	DampPos	% (98)	x	x	x	x				x	x	x	x	RD	Y
AV-11	Damp-PosMax_FH	% (98)	x	x	x	x	x	x						RD	Y
AV-12	Damp-PosMin_FH	% (98)	x	x	x	x	x	x						RD	Y
AV-13	Damp-PosMax_RE	% (98)	x	x	x	x	x	x						RD	Y
AV-14	Damp-PosMin_RE	% (98)	x	x	x	x	x	x						RD	Y
AV-15	Damp-PosMax_TE	% (98)	x	x	x	x	x	x						RD	Y
AV-16	Damp-PosMin_TE	% (98)	x	x	x	x	x	x						RD	Y
AV-17	Damp-PosMax_RS	% (98)	x	x	x	x	x	x						RD	Y
AV-18	Damp-PosMin_RS	% (98)	x	x	x	x	x	x						RD	Y
AV-19	VolOffset_T	% (98)			x				x					WR, RD	N
AV-20	VolOffset_P	% (98)			x				x					WR, RD	N

Abbreviations ↪ 'Abbreviations' on page 26

Instance	Description	Unit	Unit										Access	Support COV	
			TCU3				TAM		TROX UNIVERSAL						
			Available with equipment function												
			FH	RR	RR RMF	EC, SC	TAM	TAM RMF	RS/RE	RS/RE RMF	PR*/PD*	PR*/PD* RMF			
AV-21	SystemDevices	– (95)	x	x	x	x	x	x	x	x	x	x	x	RD	Y
AV-22	VolflowExh	l/s (87)	x	x	x		x	x	x	x	x	x		WR, RD	N
AV-23	VolflowSup	l/s (87)	x	x	x		x	x	x	x	x	x		WR, RD	N
AV-24	SC_SetPos	% (98)	Not used												
AV-25	SC_GetPos	% (98)	Not used												
AV-26	Damp-PosMax_EC	% (98)	x	x	x	x	x	x						RD	Y
AV-27	Damp-PosMin_EC	% (98)	x	x	x	x	x	x						RD	Y
AV-28	Damp-PosMax_SC	% (98)	x	x	x	x	x	x						RD	Y
AV-29	Damp-PosMin_SC	% (98)	x	x	x	x	x	x						RD	Y
AV-30	Damp-PosMax_TS	% (98)	x	x	x	x	x	x						RD	Y
AV-31	Damp-PosMin_TS	% (98)	x	x	x	x	x	x						RD	Y
AV-32	Device_ID_0	– (95)	x	x	x	x	x	x	x	x	x	x		RD	Y
AV-33	Device_ID_1	– (95)	x	x	x	x	x	x	x	x	x	x		RD	Y
AV-34	Device_ID_2	– (95)	x	x	x	x	x	x	x	x	x	x		RD	Y
AV-35	Device_ID_3	– (95)	x	x	x	x	x	x	x	x	x	x		RD	Y
AV-36	Device_ID_4	– (95)	x	x	x	x	x	x	x	x	x	x		RD	Y
AV-37	Device_ID_5	– (95)	x	x	x	x	x	x	x	x	x	x		RD	Y
AV-38	Device_ID_6	– (95)	x	x	x	x	x	x	x	x	x	x		RD	Y
AV-39	Device_ID_7	– (95)	x	x	x	x	x	x	x	x	x	x		RD	Y
AV-40	Device_ID_8	– (95)	x	x	x	x	x	x	x	x	x	x		RD	Y
AV-41	Device_ID_9	– (95)	x	x	x	x	x	x	x	x	x	x		RD	Y
AV-42	Device_ID_10	– (95)	x	x	x	x	x	x	x	x	x	x		RD	Y
AV-43	Device_ID_11	– (95)	x	x	x	x	x	x	x	x	x	x		RD	Y
AV-44	Device_ID_12	– (95)	x	x	x	x	x	x	x	x	x	x		RD	Y
AV-45	Device_ID_13	– (95)	x	x	x	x	x	x	x	x	x	x		RD	Y
AV-46	Device_ID_14	– (95)	x	x	x	x	x	x	x	x	x	x		RD	Y
AV-47	Device_ID_15	– (95)	x	x	x	x	x	x	x	x	x	x		RD	Y
AV-48	Device_ID_16	– (95)	x	x	x	x	x	x	x	x	x	x		RD	Y

Abbreviations ↗ 'Abbreviations' on page 26

In-stance	Description	Unit	Unit										Access	Support COV
			TCU3				TAM		TROX UNIVERSAL					
			Available with equipment function											
			FH	RR	RR RMF	EC, SC	TAM	TAM RMF	RS/RE	RS/RE RMF	PR*/PD*	PR*/PD* RMF		
AV-49	Device_ID_17	– (95)	x	x	x	x	x	x	x	x	x	x	RD	Y
AV-50	Device_ID_18	– (95)	x	x	x	x	x	x	x	x	x	x	RD	Y
AV-51	Device_ID_19	– (95)	x	x	x	x	x	x	x	x	x	x	RD	Y
AV-52	Device_ID_20	– (95)	x	x	x	x	x	x	x	x	x	x	RD	Y
AV-53	Device_ID_21	– (95)	x	x	x	x	x	x	x	x	x	x	RD	Y
AV-54	Device_ID_22	– (95)	x	x	x	x	x	x	x	x	x	x	RD	Y
AV-55	Device_ID_23	– (95)	x	x	x	x	x	x	x	x	x	x	RD	Y
AV-56	VolflowAct_0	l/s (87)	x	x	x	x	x	x	x	x	x	x	RD	Y
AV-57	VolflowAct_1	l/s (87)	x	x	x	x	x	x	x	x	x	x	RD	Y
AV-58	VolflowAct_2	l/s (87)	x	x	x	x	x	x	x	x	x	x	RD	Y
AV-59	VolflowAct_3	l/s (87)	x	x	x	x	x	x	x	x	x	x	RD	Y
AV-60	VolflowAct_4	l/s (87)	x	x	x	x	x	x	x	x	x	x	RD	Y
AV-61	VolflowAct_5	l/s (87)	x	x	x	x	x	x	x	x	x	x	RD	Y
AV-62	VolflowAct_6	l/s (87)	x	x	x	x	x	x	x	x	x	x	RD	Y
AV-63	VolflowAct_7	l/s (87)	x	x	x	x	x	x	x	x	x	x	RD	Y
AV-64	VolflowAct_8	l/s (87)	x	x	x	x	x	x	x	x	x	x	RD	Y
AV-65	VolflowAct_9	l/s (87)	x	x	x	x	x	x	x	x	x	x	RD	Y
AV-66	VolflowAct_10	l/s (87)	x	x	x	x	x	x	x	x	x	x	RD	Y
AV-67	VolflowAct_11	l/s (87)	x	x	x	x	x	x	x	x	x	x	RD	Y
AV-68	VolflowAct_12	l/s (87)	x	x	x	x	x	x	x	x	x	x	RD	Y
AV-69	VolflowAct_13	l/s (87)	x	x	x	x	x	x	x	x	x	x	RD	Y
AV-70	VolflowAct_14	l/s (87)	x	x	x	x	x	x	x	x	x	x	RD	Y
AV-71	VolflowAct_15	l/s (87)	x	x	x	x	x	x	x	x	x	x	RD	Y

Abbreviations ↗ 'Abbreviations' on page 26

BACnet interface

In-stance	Description	Unit	Unit										Access	Support COV
			TCU3				TAM		TROX UNIVERSAL					
			Available with equipment function											
			FH	RR	RR RMF	EC, SC	TAM	TAM RMF	RS/RE	RS/RE RMF	PR*/PD*	PR*/PD* RMF		
AV-72	VolflowAct_16	l/s (87)	x	x	x	x	x	x	x	x	x	x	RD	Y
AV-73	VolflowAct_17	l/s (87)	x	x	x	x	x	x	x	x	x	x	RD	Y
AV-74	VolflowAct_18	l/s (87)	x	x	x	x	x	x	x	x	x	x	RD	Y
AV-75	VolflowAct_19	l/s (87)	x	x	x	x	x	x	x	x	x	x	RD	Y
AV-76	VolflowAct_20	l/s (87)	x	x	x	x	x	x	x	x	x	x	RD	Y
AV-77	VolflowAct_21	l/s (87)	x	x	x	x	x	x	x	x	x	x	RD	Y
AV-78	VolflowAct_22	l/s (87)	x	x	x	x	x	x	x	x	x	x	RD	Y
AV-79	VolflowAct_23	l/s (87)	x	x	x	x	x	x	x	x	x	x	RD	Y
AV-80	VolflowSet_R	l/s (87)									x	x	WR, RD	N
AV-81	PressSet_R	pa (53)									x	x	WR, RD	N
AV-82	Volt_AI2	volt (5)	x	x	x	x	x	x					RD	Y
AV-83	Volt_AI3	volt (5)	x	x	x	x	x	x					RD	Y
AV-84	Volt_AO2	volt (5)	x	x	x	x	x	x					WR, RD	N
AV-85	DampPosMax-Value_VE	% (98)								x	x	x	RD	Y
AV-86	DampPosMin-Value_VE	% (98)								x	x	x	RD	Y
AV-87	DampPosMax-Value_VS	% (98)								x	x	x	RD	Y
AV-88	DampPosMin-Value_VS	% (98)								x	x	x	RD	Y
AV-89	DampPosMax-Value_PKE	% (98)								x	x	x	RD	Y
AV-90	DampPosMin-Value_PKE	% (98)								x	x	x	RD	Y
AV-91	DampPosMax-Value_PKS	% (98)								x	x	x	RD	Y
AV-92	DampPosMin-Value_PKS	% (98)								x	x	x	RD	Y

Abbreviations ↪ 'Abbreviations' on page 26

Binary Value Objects

In-stance	Description	Unit										Access	Support COV
		TCU3				TAM		TROX UNIVERSAL					
		Available with equipment function											
		FH	RR	RR RMF	EC, SC	TAM	TAM RMF	RS/RE	RS/RE RMF	PR*/PD*	PR*/PD* RMF		
BV-1	LocalAlarm (COVU)	x	x	x	x	x	x	x	x	x	x	RD	Y
BV-2	SummaryAlarm (COVU)			x			x	x	x	x	x	RD	Y
BV-3	PressAlarm (COVU)			x			x			x	x	RD	Y
BV-4	ManOP_Disable	x ¹		x			x		x		x	WR, RD	N
BV-5	PressSetSel			x			x					WR, RD	N
BV-6	DI1	x	x	x	x	x	x	x	x	x	x	RD	Y
BV-7	DI2	x	x	x	x	x	x	x	x	x	x	RD	Y
BV-8	DI3	x	x	x	x	x	x	x	x	x	x	RD	Y
BV-9	DI4	x	x	x	x	x	x	x	x	x	x	RD	Y
BV-10	DI5	x	x	x	x	x	x	x	x	x	x	RD	Y
BV-11	DI6	x	x	x	x	x	x	x	x	x	x	RD	Y
BV-12	DO1	x	x	x	x	x	x	x	x	x	x	RD	Y
BV-13	DO2	x	x	x	x	x	x	x	x	x	x	RD	Y
BV-14	DO3	x	x	x	x	x	x	x	x	x	x	RD	Y
BV-15	DO4	x	x	x	x	x	x	x	x	x	x	RD	Y
BV-16	DO5	x	x	x	x	x	x	x	x	x	x	RD	Y
BV-17	DO6	x	x	x	x	x	x	x	x	x	x	RD	Y
BV-18	SC_Alarm	Not used											
BV-19	DO1_Set	x	x	x	x	x	x	x	x	x	x	WR, RD	N
BV-20	DO2_Set	x	x	x	x	x	x	x	x	x	x	WR, RD	N
BV-21	DO3_Set	x	x	x	x	x	x	x	x	x	x	WR, RD	N
BV-22	DO4_Set	x	x	x	x	x	x	x	x	x	x	WR, RD	N
BV-23	DO5_Set	x	x	x	x	x	x	x	x	x	x	WR, RD	N
BV-24	DO6_Set	x	x	x	x	x	x	x	x	x	x	WR, RD	N
BV-25	DO1_SetByLocal	x	x	x	x	x	x	x	x	x	x	RD	Y

¹ only for individually selected operating mode (stand-alone operation)

Abbreviations & 'Abbreviations' on page 26

In-stance	Description	Unit										Access	Support COV
		TCU3				TAM		TROX UNIVERSAL					
		Available with equipment function											
		FH	RR	RR RMF	EC, SC	TAM	TAM RMF	RS/RE	RS/RE RMF	PR*/PD*	PR*/PD* RMF		
BV-26	DO2_SetByLocal	x	x	x	x	x	x	x	x	x	x	RD	Y
BV-27	DO3_SetByLocal	x	x	x	x	x	x	x	x	x	x	RD	Y
BV-28	DO4_SetByLocal	x	x	x	x	x	x	x	x	x	x	RD	Y
BV-29	DO5_SetByLocal	x	x	x	x	x	x	x	x	x	x	RD	Y
BV-30	DO6_SetByLocal	x	x	x	x	x	x	x	x	x	x	RD	Y
BV-31	LocalAlarm_0	x	x	x	x	x	x	x	x	x	x	RD	Y
BV-32	LocalAlarm_1	x	x	x	x	x	x	x	x	x	x	RD	Y
BV-33	LocalAlarm_2	x	x	x	x	x	x	x	x	x	x	RD	Y
BV-34	LocalAlarm_3	x	x	x	x	x	x	x	x	x	x	RD	Y
BV-35	LocalAlarm_4	x	x	x	x	x	x	x	x	x	x	RD	Y
BV-36	LocalAlarm_5	x	x	x	x	x	x	x	x	x	x	RD	Y
BV-37	LocalAlarm_6	x	x	x	x	x	x	x	x	x	x	RD	Y
BV-38	LocalAlarm_7	x	x	x	x	x	x	x	x	x	x	RD	Y
BV-39	LocalAlarm_8	x	x	x	x	x	x	x	x	x	x	RD	Y
BV-40	LocalAlarm_9	x	x	x	x	x	x	x	x	x	x	RD	Y
BV-41	LocalAlarm_10	x	x	x	x	x	x	x	x	x	x	RD	Y
BV-42	LocalAlarm_11	x	x	x	x	x	x	x	x	x	x	RD	Y
BV-43	LocalAlarm_12	x	x	x	x	x	x	x	x	x	x	RD	Y
BV-44	LocalAlarm_13	x	x	x	x	x	x	x	x	x	x	RD	Y
BV-45	LocalAlarm_14	x	x	x	x	x	x	x	x	x	x	RD	Y
BV-46	LocalAlarm_15	x	x	x	x	x	x	x	x	x	x	RD	Y
BV-47	LocalAlarm_16	x	x	x	x	x	x	x	x	x	x	RD	Y
BV-48	LocalAlarm_17	x	x	x	x	x	x	x	x	x	x	RD	Y
BV-49	LocalAlarm_18	x	x	x	x	x	x	x	x	x	x	RD	Y
BV-50	LocalAlarm_19	x	x	x	x	x	x	x	x	x	x	RD	Y
BV-51	LocalAlarm_20	x	x	x	x	x	x	x	x	x	x	RD	Y
BV-52	LocalAlarm_21	x	x	x	x	x	x	x	x	x	x	RD	Y
BV-53	LocalAlarm_22	x	x	x	x	x	x	x	x	x	x	RD	Y
BV-54	LocalAlarm_23	x	x	x	x	x	x	x	x	x	x	RD	Y

¹ only for individually selected operating mode (stand-alone operation)

Abbreviations ↪ *'Abbreviations'* on page 26

4.2 Modbus interface

Application

The expansion module EM-IP supports the following Modbus interface functions in the Modbus protocol settings:

- Modbus is an open serial master-slave communication protocol which has become a de facto standard for the industry
- The master (e.g. central BMS) can address a number of slaves (EASYLAB volume flow controllers) and use Modbus functions to request information from individual data points
- Data access is based on numbered data registers which the master has to define in order to request data using Modbus functions
- The slave responds by either returning the requested information or an exception code (error)
- Example: The Read Input Registers function (register no. 3) returns the volume flow rate actual value of the addressed controller
- General information for a Modbus device can be read out using the Read Device Identification function

Abbreviations

EASYLAB:

- FH - Fume cupboard controller
- RR - Room controller for supply air or extract air (RS, RE, PC)

- RR RMF - Room controller with active room management function
- EC, SC - Single controller for supply air or extract air (EC, SC)
- TAM - Adapter module
- TAM RMF - Adapter module with active room management function
- WR - Defaults for the volume flow controller or room, from the central BMS
- RD - Data provided by the volume flow controller or room

TROX UNIVERSAL CONTROLLER:

- RS/RE - Volume flow controllers for supply or extract air
- RS/RE RMF - Volume flow controller with active room management function
- PR*/PD* - Room pressure controller or duct for supply or extract air
- PR*/PD* RMF - Room pressure controller or duct with active room management function

Modbus interface

Modbus functions

Function no.	Description	Meaning
1 (0x01)	Read Coils	Read states of 1 to 8 bits according to bit list
3 (0x03)	Read Holding Registers	Read several consecutive registers
4 (0x04)	Read Input Registers	Read several consecutive registers
5 (0x05)	Write Single Coil	Write state of a single bit
6 (0x06)	Write Single Register	Write single register

Exception codes

Codes	Description	Meaning
1	Illegal Function Code	Unknown function or subfunction code
2	Illegal Data Address	Invalid register address
3	Illegal Data Value	Inconsistent coding for number of registers/bytes, data value

Exception codes (error codes) are returned in case of invalid function or register access.

Bit list for ReadCoil/WriteSingleCoil functions

No.	Bit Description	Unit										Access
		TCU3				TAM		TROX UNIVERSAL				
		Available with equipment function										
		FH	RR	RR RMF	EC, SC	TAM	TAM RMF	RS/ RE	RS/RE RMF	PR*/ PD*	PR*/PD* RMF	
0	ManOP_Disable	x ¹		x			x		x		x	WR, RD
1	PressSetSel			x			x					WR, RD
2	Local Alarm	x	x	x	x	x	x					RD
3	SummaryAlarm			x			x					RD
4	PressAlarm			x			x					RD
5	SC_SetlockHigh-Prio	Not used										
6	SC_GetLockHigh-Prio	Not used										
7	SC_Alarm	Not used										
8	LocalAlarm_0	x	x	x	x	x	x					RD
9	LocalAlarm_1	x	x	x	x	x	x					RD
10	LocalAlarm_2	x	x	x	x	x	x					RD
11	LocalAlarm_3	x	x	x	x	x	x					RD
12	LocalAlarm_4	x	x	x	x	x	x					RD
13	LocalAlarm_5	x	x	x	x	x	x					RD
14	LocalAlarm_6	x	x	x	x	x	x					RD
15	LocalAlarm_7	x	x	x	x	x	x					RD
16	LocalAlarm_8	x	x	x	x	x	x					RD
17	LocalAlarm_9	x	x	x	x	x	x					RD
18	LocalAlarm_10	x	x	x	x	x	x					RD
19	LocalAlarm_11	x	x	x	x	x	x					RD
20	LocalAlarm_12	x	x	x	x	x	x					RD
21	LocalAlarm_13	x	x	x	x	x	x					RD
22	LocalAlarm_14	x	x	x	x	x	x					RD
23	LocalAlarm_15	x	x	x	x	x	x					RD
24	LocalAlarm_16	x	x	x	x	x	x					RD
25	LocalAlarm_17	x	x	x	x	x	x					RD
26	LocalAlarm_18	x	x	x	x	x	x					RD
27	LocalAlarm_19	x	x	x	x	x	x					RD

¹ only for individually selected operating mode (stand-alone operation)

Bits are read with function 1 (RD) or written with function 5 (WR).

Abbreviations ↪ 'Abbreviations' on page 26

Modbus interface

Bit		Unit										Access
No.	Description	TCU3				TAM		TROX UNIVERSAL				
		Available with equipment function										
		FH	RR	RR RMF	EC, SC	TAM	TAM RMF	RS/ RE	RS/RE RMF	PR*/ PD*	PR*/PD* RMF	
28	LocalAlarm_20	x	x	x	x	x	x					RD
29	LocalAlarm_21	x	x	x	x	x	x					RD
30	LocalAlarm_22	x	x	x	x	x	x					RD
31	LocalAlarm_23	x	x	x	x	x	x					RD

¹ only for individually selected operating mode (stand-alone operation)

Bits are read with function 1 (RD) or written with function 5 (WR).

Abbreviations 'Abbreviations' on page 26

Register list for Read***Registers and Write***Registers functions

No.	Register Description	Unit										Access
		TCU3				TAM		TROX UNIVERSAL				
		Available with equipment function										
		FH	RR	RR RMF	EC, SC	TAM	TAM RMF	RS/ RE	RS/RE RMF	PR*/ PD*	PR*/PD* RMF	
0	Mode	x ¹		x			x		x		x	WR, RD
1	ManOP_Disable	x ¹		x			x		x		x	WR, RD
2	ModeAct	x	x	x	x				x		x	RD
3	VolflowAct	x	x	x	x			x	x	x	x	RD
4	VolflowSet	x	x	x	x			x	x			RD
5	VelocityAct	x										RD
6	VelocitySet	x										RD
7	VolTotalExh	x	x	x	x	x	x	x	x	x	x	RD
8	VolTotalSup	x	x	x	x	x	x	x	x	x	x	RD
9	VolOffset_T			x			x					WR, RD
10	VolOffset_P			x			x					WR, RD
11	PressAct			x			x			x	x	RD
12	PressSet			x			x			x	x	RD
13	PressSetSel			x			x					WR, RD
14	DampPos	x	x	x	x			x	x	x	x	RD
15	DampPosMax_FH - Value	x	x	x	x	x	x					RD
16	DampPosMax_FH - Status	x	x	x	x	x	x					RD
17	DampPosMin_FH - Value	x	x	x	x	x	x					RD
18	DampPosMin_FH - Status	x	x	x	x	x	x					RD
19	DampPosMax_RE - Value	x	x	x	x	x	x					RD
20	DampPosMax_RE - Status	x	x	x	x	x	x					RD
21	DampPosMin_RE - Value	x	x	x	x	x	x					RD
22	DampPosMin_RE - Status	x	x	x	x	x	x					RD

¹ only for individually selected operating mode (stand-alone operation)

Abbreviations ↪ 'Abbreviations' on page 26

Modbus interface

Register		Unit										Access
No.	Description	TCU3				TAM		TROX UNIVERSAL				
		Available with equipment function										
		FH	RR	RR RMF	EC, SC	TAM	TAM RMF	RS/ RE	RS/RE RMF	PR*/ PD*	PR*/PD* RMF	
23	DampPosMax_TE - Value	x	x	x	x	x	x					RD
24	DampPosMax_TE - Status	x	x	x	x	x	x					RD
25	DampPosMin_TE - Value	x	x	x	x	x	x					RD
26	DampPosMin_TE - Status	x	x	x	x	x	x					RD
27	DampPosMax_RS - Value	x	x	x	x	x	x					RD
28	DampPosMax_RS - Status	x	x	x	x	x	x					RD
29	DampPosMin_RS - Value	x	x	x	x	x	x					RD
30	DampPosMin_RS - Status	x	x	x	x	x	x					RD
31	LocalAlarm	x	x	x	x	x	x	x	x	x	x	RD
32	SummaryAlarm			x			x	x	x	x	x	RD
33	PressAlarm			x			x			x	x	RD
34	WireSensorPos	x										RD
35	SwitchPos	x										RD
36	RoomModeAct			x			x	x	x	x	x	RD
37	SystemDevices	x	x	x	x	x	x	x	x	x	x	RD
38	SunBlind			x			x		x		x	WR, RD
39	StateDI	x	x	x	x	x	x	x	x	x	x	RD
40	StateDO	x	x	x	x	x	x	x	x	x	x	RD
41	VolflowExh	x	x	x		x	x	x	x	x	x	WR, RD
42	VolflowSup	x	x	x		x	x	x	x	x	x	WR, RD
43	SC_SetLockHighPrio	Not used										
44	SC_GetLockHighPrio	Not used										
45	SC_SetPos - Value	Not used										
46	SC_SetPos - Status	Not used										
47	SC_GetPos	Not used										
48	SC_Alarm	Not used										

¹ only for individually selected operating mode (stand-alone operation)

Abbreviations ↪ 'Abbreviations' on page 26

No.	Register Description	Unit										Access
		TCU3				TAM		TROX UNIVERSAL				
		Available with equipment function										
		FH	RR	RR RMF	EC, SC	TAM	TAM RMF	RS/ RE	RS/RE RMF	PR*/ PD*	PR*/PD* RMF	
49	DampPosMax_EC - Value	x	x	x	x	x	x					RD
50	DampPosMax_EC -- Status	x	x	x	x	x	x					RD
51	DampPosMin_EC - Value	x	x	x	x	x	x					RD
52	DampPosMin_EC -- Status	x	x	x	x	x	x					RD
53	DampPosMax_SC - Value	x	x	x	x	x	x					RD
54	DampPosMax_SC -- Status	x	x	x	x	x	x					RD
55	DampPosMin_SC - Value	x	x	x	x	x	x					RD
56	DampPosMin_SC -- Status	x	x	x	x	x	x					RD
57	DampPosMax_TS - Value	x	x	x	x	x	x					RD
58	DampPosMax_TS -- Status	x	x	x	x	x	x					RD
59	DampPosMin_TS - Value	x	x	x	x	x	x					RD
60	DampPosMin_TS -- Status	x	x	x	x	x	x					RD
61	DO_Set	x	x	x	x	x	x	x	x	x	x	WR, RD
62	DO_SetByLocal	x	x	x	x	x	x	x	x	x	x	RD
63	LocalAlarm_* (0 – 7)	x	x	x	x	x	x	x	x	x	x	RD
64	LocalAlarm_* (8 – 15)	x	x	x	x	x	x	x	x	x	x	RD
65	LocalAlarm_* (16 – 23)	x	x	x	x	x	x	x	x	x	x	RD
66	Device_ID_0	x	x	x	x	x	x	x	x	x	x	RD
67	Device_ID_1	x	x	x	x	x	x	x	x	x	x	RD
68	Device_ID_2	x	x	x	x	x	x	x	x	x	x	RD
69	Device_ID_3	x	x	x	x	x	x	x	x	x	x	RD
70	Device_ID_4	x	x	x	x	x	x	x	x	x	x	RD
71	Device_ID_5	x	x	x	x	x	x	x	x	x	x	RD
72	Device_ID_6	x	x	x	x	x	x	x	x	x	x	RD

¹ only for individually selected operating mode (stand-alone operation)

Abbreviations ↗ 'Abbreviations' on page 26

Modbus interface

Register		Unit										Access
No.	Description	TCU3				TAM		TROX UNIVERSAL				
		Available with equipment function										
		FH	RR	RR RMF	EC, SC	TAM	TAM RMF	RS/RE	RS/RE RMF	PR*/PD*	PR*/PD* RMF	
73	Device_ID_7	x	x	x	x	x	x	x	x	x	x	RD
74	Device_ID_8	x	x	x	x	x	x	x	x	x	x	RD
75	Device_ID_9	x	x	x	x	x	x	x	x	x	x	RD
76	Device_ID_10	x	x	x	x	x	x	x	x	x	x	RD
77	Device_ID_11	x	x	x	x	x	x	x	x	x	x	RD
78	Device_ID_12	x	x	x	x	x	x	x	x	x	x	RD
79	Device_ID_13	x	x	x	x	x	x	x	x	x	x	RD
80	Device_ID_14	x	x	x	x	x	x	x	x	x	x	RD
81	Device_ID_15	x	x	x	x	x	x	x	x	x	x	RD
82	Device_ID_16	x	x	x	x	x	x	x	x	x	x	RD
83	Device_ID_17	x	x	x	x	x	x	x	x	x	x	RD
84	Device_ID_18	x	x	x	x	x	x	x	x	x	x	RD
85	Device_ID_19	x	x	x	x	x	x	x	x	x	x	RD
86	Device_ID_20	x	x	x	x	x	x	x	x	x	x	RD
87	Device_ID_21	x	x	x	x	x	x	x	x	x	x	RD
88	Device_ID_22	x	x	x	x	x	x	x	x	x	x	RD
89	Device_ID_23	x	x	x	x	x	x	x	x	x	x	RD
90	VolflowAct_0	x	x	x	x	x	x	x	x	x	x	RD
91	VolflowAct_1	x	x	x	x	x	x	x	x	x	x	RD
92	VolflowAct_2	x	x	x	x	x	x	x	x	x	x	RD
93	VolflowAct_3	x	x	x	x	x	x	x	x	x	x	RD
94	VolflowAct_4	x	x	x	x	x	x	x	x	x	x	RD
95	VolflowAct_5	x	x	x	x	x	x	x	x	x	x	RD
96	VolflowAct_6	x	x	x	x	x	x	x	x	x	x	RD
97	VolflowAct_7	x	x	x	x	x	x	x	x	x	x	RD
98	VolflowAct_8	x	x	x	x	x	x	x	x	x	x	RD
99	VolflowAct_9	x	x	x	x	x	x	x	x	x	x	RD
100	VolflowAct_10	x	x	x	x	x	x	x	x	x	x	RD
101	VolflowAct_11	x	x	x	x	x	x	x	x	x	x	RD
102	VolflowAct_12	x	x	x	x	x	x	x	x	x	x	RD
103	VolflowAct_13	x	x	x	x	x	x	x	x	x	x	RD
104	VolflowAct_14	x	x	x	x	x	x	x	x	x	x	RD
105	VolflowAct_15	x	x	x	x	x	x	x	x	x	x	RD

¹ only for individually selected operating mode (stand-alone operation)

Abbreviations ↪ 'Abbreviations' on page 26

No.	Register Description	Unit										Access
		TCU3				TAM		TROX UNIVERSAL				
		Available with equipment function										
		FH	RR	RR RMF	EC, SC	TAM	TAM RMF	RS/ RE	RS/RE RMF	PR*/ PD*	PR*/PD* RMF	
106	VolflowAct_16	x	x	x	x	x	x	x	x	x	x	RD
107	VolflowAct_17	x	x	x	x	x	x	x	x	x	x	RD
108	VolflowAct_18	x	x	x	x	x	x	x	x	x	x	RD
109	VolflowAct_19	x	x	x	x	x	x	x	x	x	x	RD
110	VolflowAct_20	x	x	x	x	x	x	x	x	x	x	RD
111	VolflowAct_21	x	x	x	x	x	x	x	x	x	x	RD
112	VolflowAct_22	x	x	x	x	x	x	x	x	x	x	RD
113	VolflowAct_23	x	x	x	x	x	x	x	x	x	x	RD
114	VolflowSet_R								x		x	WR, RD
115	PressSet_R									x	x	WR, RD
116	Volt_AI2	x	x	x	x	x	x					RD
117	Volt_AI3	x	x	x	x	x	x					RD
118	Volt_AO2	x	x	x	x	x	x					WR, RD
119	DampPosMax_VE - Value							x	x	x	x	RD
120	DampPosMax_VE -- Status							x	x	x	x	RD
121	DampPosMin_VE - Value							x	x	x	x	RD
122	DampPosMin_VE -- Status							x	x	x	x	RD
123	DampPosMax_VS - Value							x	x	x	x	RD
124	DampPosMax_VS - Status							x	x	x	x	RD
125	DampPosMin_VS - Value							x	x	x	x	RD
126	DampPosMin_VS - Status							x	x	x	x	RD
127	DampPosMax_PKE - Value							x	x	x	x	RD
128	DampPosMax_PKE - Status							x	x	x	x	RD
129	DampPosMin_PKE - Value							x	x	x	x	RD

¹ only for individually selected operating mode (stand-alone operation)

Abbreviations ↪ 'Abbreviations' on page 26

Modbus interface

Register		Unit										Access
No.	Description	TCU3				TAM		TROX UNIVERSAL				
		Available with equipment function										
		FH	RR	RR RMF	EC, SC	TAM	TAM RMF	RS/ RE	RS/RE RMF	PR*/ PD*	PR*/PD* RMF	
130	DampPosMin_PKE - Status							x	x	x	x	RD
131	DampPosMax_PKS - Value							x	x	x	x	RD
132	DampPosMax_PKS - Status							x	x	x	x	RD
133	DampPosMin_PKS - Value							x	x	x	x	RD
134	+DampPosMin_PKS - Status							x	x	x	x	RD

¹ only for individually selected operating mode (stand-alone operation)

Abbreviations ↪ 'Abbreviations' on page 26

4.3 Data points – detailed description

The following is a detailed description of the information that each data point provides; input variables and output variables are described separately:

- Name of data point
- Access as viewed from the central BMS
 - WR – Defaults for the volume flow controller or room, from the central BMS
 - RD – Data provided by the volume flow controller or room
- List of volume flow controller equipment functions for which the variable is available
 - FH – Fume cupboard controller
 - RR – Room controller for supply air or extract air (RS, RE, PC)
 - RR RMF – Room controller with active room management function
 - EC, SC – Single controller for supply air or extract air (EC, SC)
 - TAM – Adapter module
 - TAM RMF – Adapter module with active room management function
- Unit of measure (applies only to BACnet objects of type Analogue Value Object)
- Function and special functional values with their meaning
- Access to the data point using a BACnet object or Modbus register

TROX UNIVERSAL CONTROLLER:

RS/RE	- Volume flow controllers for supply or extract air
RS/RE RMF	- Volume flow controller with active room management function
PR*/PD*	- Room pressure controller or duct for supply or extract air
PR*/PD* RMF	- Room pressure controller or duct with active room management function

4.3.1 Input variables

MODE

BMS access: WR RD

Equipment function:

- EASYLAB
 - FH, RR with RMFM, TAM with RMF
- TROX UNIVERSAL
 - RE/RS with RMF, PR*/PD* with RMF

Function

- FH: Operating mode default setting for a single fume cupboard controller, only with individual operating mode default setting (stand-alone operation)
- RMF: Operating mode default setting for the entire room



- *The valid binding of the input variable results in a valid operating mode default setting via BACnet or Modbus*
- *The invalid binding or no setting does not lead to any operating mode default setting in the controller or room.*
- *Which operating mode is then used depends on the default options available on the controller*

Functional values (BACnet / Modbus)

- 1/0 = No default: The central BMS does not default an operating mode for the controller or room. The operating mode is set locally, e.g. on the room control panel, on the fume cupboard control panel, or using switch contacts. If the operating mode is not set locally, the controller activates standard mode.
- 2/1 = Standard mode: Normal operation in the day-time (in Germany: usually according to DIN 1946, part 7, 25 m³/h extract air per m² main useful floor area)
- 3/2 = Reduced operation: Low mode in comparison to standard mode, e.g. as a night-time setback
- 4/3 = Increased operation: High mode in comparison to standard mode, e.g. in an emergency
- 5/4 = Shut-off: Shut-off of the volume flow controller, e.g. to save energy at night or to shut down the system
- 6/5 = OPEN position: Open position of the volume flow controller

Data point

- BACnet: Multistate Value Object – Instance MV-2
- Modbus: Register 0

Sunblind

BMS access: WR RD

Equipment function:

- EASYLAB
 - FH, RR with RMF, TAM with RMF
- TROX UNIVERSAL
 - RE/RS with RMF, PR*/PD* with RMF

Function

- Control input signal for shading, connected to the controller or adapter module
- Switch outputs DO5 and DO6 will be used
- This BACnet or Modbus default overrides any other defaults from the local room control panel

Data point

- BACnet: Multistate Value Object – Instance MV-6
 - 1 = No default
 - 2 = Close blinds (activate switch output DO6)
 - 3 = Open blinds (activate switch output DO5)
- Modbus: Register 38
 - 0 = Close blinds
 - 1 = Open blinds
 - 0xFF = No default

SC_SetLockHighPrio

Equipment function: not available

VolOffset_T

BMS access: WR RD

Equipment function:

- EASYLAB
 - RR with RMF, TAM with RMF
- TROX UNIVERSAL
 - not used

Unit/value range:

- BACnet: Percentage value in increments of 0.5 %
- Modbus: 0–200 (200 corresponds to 100 %)

Function

- Signalling of an external volume flow rate shift, e.g. for adjusting the room air change rate or for external temperature control
- The shift signal is transferred as a percentage value of a volume flow rate change range that has been configured in the controller

Data point

- BACnet: Analog Value Object – Instance AV-19
- Modbus: Register 9

VolOffset_P

BMS access: WR RD

Equipment function:

- EASYLAB
 - RR with RMF, TAM with RMF
- TROX UNIVERSAL
 - not used

Unit/value range:

- BACnet: Percentage value in increments of 0.5 %
- Modbus: 0–200 (200 corresponds to 100%)

Function

- Signalling of a flow rate setpoint shift for external differential pressure control
- The shift signal is transferred as a percentage value of a volume flow rate change range that has been configured in the controller

Data point

- BACnet: Analog Value Object – Instance AV-20
- Modbus: Register 10

VolflowExh

BMS access: WR RD

Equipment function:

- EASYLAB
 - FH, RR, RR with RMF, TAM, TAM with RMF
- TROX UNIVERSAL
 - RE/RS, RE/RS with RMF, PR*/PD*, PR*/PD* with RMF

Unit: l/s

Function

- Integration of an extract air flow into the room balance of the system
- This default volume flow is considered for all volume flow calculations (balance and setpoint values)

Data point

- BACnet: Analog Value Object – Instance AV-22
- Modbus: Register 41

VolflowSup

BMS access: WR RD

Equipment function:

- EASYLAB
 - FH, RR, RR with RMF, TAM, TAM with RMF
- TROX UNIVERSAL
 - RE/RS, RE/RS with RMF, PR*/PD*, PR*/PD* with RMF

Unit: l/s

Function

- Integration of a supply air flow into the room balance of the system
- This default volume flow is considered for all volume flow calculations (balance and setpoint values)

Data point

- BACnet: Analog Value Object – Instance AV-23
- Modbus: Register 42

SC_SetPos

Equipment function: not available

VolflowSet_R

BMS access: WR RD

Equipment function:

- EASYLAB
 - not used
- TROX UNIVERSAL
 - RE/RS, RE/RS with RMF, PR*/PD*, PR*/PD* with RMF

Unit: l/s

Function

- Default setting of volume flow rate setpoint (room), only for standard mode

Data point

- BACnet: Analog Value Object – Instance AV-80
- Modbus: Register 114

PressSet_R

BMS access: WR RD

Equipment function:

- EASYLAB
 - not used
- TROX UNIVERSAL
 - PR*/PD*, PR*/PD* with RMF

Unit: Pa

Function

- Local default setting of room pressure or duct pressure setpoint value

Data point

- BACnet: Analog Value Object – Instance AV-81
- Modbus: Register 115

VoIt_AO2

BMS access: WR RD

Equipment function:

- EASYLAB
 - FH, RR, RR with RMF, EC, SC, TAM, TAM with RMF
- TROX UNIVERSAL
 - not used

Unit: V DC

Function

- Enabling/disabling manual control
- Upon enabling manual control the corresponding symbol appears on the control panel.
- Default setting of voltage for analogue output AO2
- 0 – 10 V DC, in increments of 0.1 V

Data point

- BACnet: Analog Value Object – Instance AV-84
- Modbus: Register 118

ManOp_Disable

BMS access: WR RD

Equipment function:

- EASYLAB
 - FH, RR with RMF, TAM with RMF
- TROX UNIVERSAL
 - RE/RS with RMF, PR*/PD* with RMF

Function

- Enabling/disabling manual control
- Upon enabling manual control the corresponding symbol appears on the control panel.



For further information on manual control please refer to the EASYLAB design manual.

- FH: Operating mode default setting for a fume cupboard controller, only with individual operating mode default setting (stand-alone operation)
- RMF: operating mode default setting for the entire room

Functional values

- 0: Manual control has been enabled on the control panel.
Operating mode defaults set on DI override BACnet or Modbus defaults.
- 1: Manual control has been disabled on the control panel.
Operating mode default settings from BACnet or Modbus have the highest priority.

Data point

- BACnet: Binary Value Object – Instance BV-4
- Modbus: Bit list - bit 0 or register 1

PressSetSel

BMS access: WR RD

Equipment function:

- EASYLAB
 - RR with RMF, TAM with RMF
- TROX UNIVERSAL
 - not used

Function

- Input for switching between two pressure set points when differential pressure control of the system is activated (setpoint values stored in the room management function).

Functional values

- 0: Use differential pressure setpoint 1
- 1: Use differential pressure setpoint 2

Data point

- BACnet: Binary Value Object – Instance BV-5
- Modbus: Bit list - bit 1 or register 13

DO*_Set (BACnet) / DO_Set (Modbus)

BMS access: WR RD

Equipment function:

- EASYLAB
 - FH, RR, RR with RMF, EC, SC, TAM, TAM with RMF
- TROX UNIVERSAL
 - RE/RS, RE/RS with RMF, PR*/PD*, PR*/PD* with RMF

Function

- Control input signal for unused switch outputs DO1 – DO6 of the controller or adapter module

Data point

- BACnet: Binary Value Object – Instance BV-19 (DO1_Set) – Instance BV-24 (DO6_Set)
 - 0 = output inactive
 - 1 = output active
- Modbus: Register 61 – bit 0 (DO1_Set) – bit 5 (DO6_Set)
 - Bit not set = output inactive
 - Bit set = output active

4.3.2 Output variables

ReadDeviceIdentification (only Modbus)

BMS access: RD

Equipment function: FH, RR, RR with RMF, EC, SC, TAM, TAM with RMF

Function

- Provides status information for the Modbus device

Data point

- BACnet : see Device Object description [↪ on page 28](#)
- Modbus: Device response
 - Byte 0: Slave Address 1-99
 - Byte 1: Function Code 0x2B
 - Byte 3: Read Device ID Code 0x01
 - Byte 4: Conformity Level 0x01
 - Byte 5: More Follows 0x00
 - Byte 6: Next Object ID 0x00
 - Byte 7: Number of Objects 0x03
 - Byte 8: ID: VendorName 0x00
 - Byte 9: Obj-Length 9
 - Byte 10-18: Obj-Value "TROX GmbH"
 - Byte 19 ID: ProductCode 0x01
 - Byte 20: Obj-Length 23
 - Byte 21-43: Obj-Value "EM-IP - EASYLAB"
 - Byte 44 ID: MajMinRevision 0x02
 - Byte 45: Obj-Length 4
 - Byte 46-49: Obj-Value "V3.0"

ModeAct

BMS access: RD

Equipment function:

- EASYLAB
 - FH, RR, RR with RMF, EC, SC
- TROX UNIVERSAL
 - RE/RS with RMF, PR*/PD* with RMF

Function

- Output of the operating mode of the volume flow controller



For more information on each operating mode see the description of the 'Mode' input variable [↪ Chapter 4.3.1 'Input variables' on page 47](#).

Functional values (BACnet / Modbus)

- 1/0 = No default
- 2/1 = Standard mode
- 3/2 = Reduced operation
- 4/3 = Increased operation
- 5/4 = Shut-off
- 6/5 = OPEN position

Data point

- BACnet: Multistate Value Object – Instance MV-3
- Modbus: Register 2

RoomModeAct

BMS access: RD

Equipment function:

- EASYLAB
 - RR with RMF, TAM with RMF
- TROX UNIVERSAL
 - RE/RS, RE/RS with RMF, PR*/PD*, PR*/PD* with RMF

Function

- Output of the room operating mode



For more information on each operating mode see the description of the 'Mode' input variable

Functional values (BACnet / Modbus)

- 1/0 = No default
- 2/1 = Standard mode
- 3/2 = Reduced operation
- 4/3 = Increased operation
- 5/4 = Shut-off
- 6/5 = OPEN position

Data point

- BACnet: Multistate Value Object – Instance MV-4
- Modbus: Register 36

SwitchPos

BMS access: RD

Equipment function:

- EASYLAB
 - FH
- TROX UNIVERSAL
 - not used

Function

- Output of the current switching step of the fume cupboard as a numeric value if the fume cupboard controller is equipped with switch contacts for 2-point or 3-point control (FH2P, FH-3P)

Data point

- BACnet:
 - Multistate Value Object – Instance MV-5
 - 1 = invalid state
 - 2 = switching step 1
 - 3 = switching step 2
 - 4 = switching step 3
- Modbus:
 - Register 35
 - 0 = invalid state
 - 1 = switching step 1
 - 2 = switching step 2
 - 3 = switching step 3

SC_GetLockHighPrio

Equipment function: not available

VolflowSet

BMS access: RD

Equipment function:

- EASYLAB
 - FH, RR, RR with RMF, EC, SC
- TROX UNIVERSAL
 - RE/RS, RE/RS with RMF

Unit: l/s

Function

- Output of the volume flow rate setpoint value for the volume flow controller

Data point

- BACnet: Analog Value Object – Instance AV-1
- Modbus: Register 4

VolflowAct

BMS access: RD

Equipment function:

- EASYLAB
 - FH, RR, RR with RMF, EC, SC
- TROX UNIVERSAL
 - RE/RS, RE/RS with RMF, PR*/PD*, PR*/PD* with RMF

Unit: l/s

Function

- Output of the volume flow rate actual value of the volume flow controller

Data point

- BACnet: Analog Value Object – Instance AV-2
- Modbus: Register 3

VolTotalExh

BMS access: RD

Equipment function:

- EASYLAB
 - FH, RR, RR with RMF, EC, SC, TAM, TAM with RMF
- TROX UNIVERSAL
 - RE/RS, RE/RS with RMF, PR*/PD*, PR*/PD* with RMF

Unit: l/s

Function

- Output of the total extract air volume flow rate of an room



This includes the extract air volume flow rates of all fume cupboards and extract air controllers as well as any additional extract air volume flow rates (constant and variable) from other controllers.

Data point

- BACnet: Analog Value Object – Instance AV-3
- Modbus: Register 7

VolTotalSup

BMS access: RD

Equipment function:

- EASYLAB
 - FH, RR, RR with RMF, EC, SC, TAM, TAM with RMF
- TROX UNIVERSAL
 - RE/RS, RE/RS with RMF, PR*/PD*, PR*/PD* with RMF

Unit: l/s

Function

- Output of the total supply air flow rate of an room



This includes the supply air volume flow rates of all supply air controllers as well as any additional supply air volume flow rates (constant and variable).

Data point

- BACnet: Analog Value Object – Instance AV-4
- Modbus: Register 8

PressSet

BMS access: RD

Equipment function:

- EASYLAB
 - RR with RMF, TAM with RMF
- TROX UNIVERSAL
 - PR*/PD*, PR*/PD* with RMF

Unit: Pa

Function

- Output of the differential pressure control setpoint value within the system

Data point

- BACnet: Analog Value Object – Instance AV-5
- Modbus: Register 12

PressAct

BMS access: RD

Equipment function:

- EASYLAB
 - RR with RMF, TAM with RMF
- TROX UNIVERSAL
 - PR*/PD*, PR*/PD* with RMF

Unit: Pa

Function

- Output of the differential pressure control actual value within the system



The actual value is recorded by a differential pressure transducer connected to the RR with RMF or to the TAM with RMF.

Data point

- BACnet: Analog Value Object – Instance AV-6
- Modbus: Register 11

VelocitySet

BMS access: RD

Equipment function:

- EASYLAB
 - FH
- TROX UNIVERSAL
 - not used

Unit: m/s

Function

- Output of the face velocity setpoint value if the fume cupboard controller is equipped with a face velocity transducer (FH-VS)

Data point

- BACnet: Analog Value Object – Instance AV-7
- Modbus: Register 6

VelocityAct

BMS access: RD

Equipment function:

- EASYLAB
 - FH
- TROX UNIVERSAL
 - not used

Unit: m/s

Function

- Output of the face velocity actual value if the fume cupboard controller is equipped with a face velocity transducer (FH-VS)

Data point

- BACnet: Analog Value Object – Instance AV-8
- Modbus: Register 5

WireSensorPos

BMS access: RD

Equipment function:

- EASYLAB
 - FH
- TROX UNIVERSAL
 - not used

Unit/value range:

- BACnet: Percentage value in increments of 0.5 %
- Modbus: 0–200 (200 corresponds to 100 %)

Function

- Output of the sash position of the fume cupboard as a percentage value between the closed position (0 %) and the open position (100 %) (Applies only if the fume cupboard controller is equipped with a sash distance sensor (FH-DS, FH-DV, FH-VD))

Data point

- BACnet: Analog Value Object – Instance AV-9
- Modbus: Register 34

SystemDevices

BMS access: RD

Equipment function:

- EASYLAB
 - FH, RR, RR with RMF, EC, SC, TAM, TAM with RMF
- TROX UNIVERSAL
 - RE/RS, RE/RS with RMF, PR*/PD*, PR*/PD* with RMF

Function

- Number of identified EASYLAB system components

Data point

- BACnet: Analog Value Object – Instance AV-21
- Modbus Register 37

SC_GetPos

Equipment function: not available

Device_ID_*

BMS access: RD

Equipment function:

- EASYLAB
 - FH, RR, RR with RMF, EC, SC, TAM, TAM with RMF
- TROX UNIVERSAL
 - RE/RS, RE/RS with RMF, PR*/PD*, PR*/PD* with RMF

Function

- Output of the Device ID of the device being addressed (0 – 23)
- The Device_ID_* data points (0 – 23) of the EM-IP expansion module contain the Device ID of each controller (1 – 24)
- Controllers are automatically assigned a Device ID as part of the configuration procedure
- Controllers are automatically assigned to the data points

**Example**

- A controller has Device ID 5
- The device with device ID 5 is automatically assigned to VolflowAct_4 and LocalAlarm_4.
- Devices with device ID 0 are not displayed.
- If the device ID is assigned twice, an error message is displayed in the web interface.

Data point

- BACnet: Analogue Value Object – Instance AV-32 (Device_ID_0) – Instance AV-55 (Device_ID_23)
- Modbus Register 37

VolflowAct_*

BMS access: RD

Equipment function: FH, RR, RR with RMF, EC, SC, TAM, TAM with RMF

Unit: l/s

Function

- Output of the volume flow rate actual value of the bus user, addressed by device ID, i.e. device ID4 ⇔ VolflowAct_3

Data point

- BACnet: Analogue Value Object – Instance AV-56 (VolFlowAct_0) – Instance AV-79 (VolFlowAct_23)
- Modbus: Register 90 (VolFlowAct_0) – 113 (VolFlowAct_23)

Volt_AI2

BMS access: RD

Equipment function:

- EASYLAB
 - FH, RR, RR with RMF, EC, SC, TAM, TAM with RMF
- TROX UNIVERSAL
 - not used

Unit: V DC

Function

- Output of the voltage at analogue input AI2
- 0 – 10 V DC, in increments of 0.1 V

Data point

- BACnet: Analogue Value Object – Instance AV-82
- Modbus: Register 116

Volt_AI3

BMS access: RD

Equipment function:

- EASYLAB
 - FH, RR, RR with RMF, EC, SC, TAM, TAM with RMF
- TROX UNIVERSAL
 - not used

Unit: V DC

Function

- Output of the voltage at analogue input AI3
- 0 – 10 V DC, in increments of 0.1 V

Data point

- BACnet: Analogue Value Object – Instance AV-83
- Modbus: Register 117

LocalAlarm

BMS access: RD

Equipment function:

- EASYLAB
 - FH, RR, RR with RMF, EC, SC, TAM, TAM with RMF
- TROX UNIVERSAL
 - RE/RS, RE/RS with RMF, PR*/PD*, PR*/PD* with RMF

Function

- Output of a local alarm for a fume cupboard controller, extract air controller, supply air controller, room controller or TAM



Alarm conditions can be defined using the EasyConnect configuration software.

Functional values

- 0 = No local alarm
- 1 = Local alarm

Data point

- BACnet: Binary Value Object – Instance BV-1
- Modbus: Bit list - bit 2 or register 31

SummaryAlarm

BMS access: RD

Equipment function:

- EASYLAB
 - RR with RMF, TAM with RMF
- TROX UNIVERSAL
 - RE/RS with RMF, PR*/PD* with RMF

Function

- Output of a consolidated alarm



An alarm signal is generated when a controller emits an alarm or fault message.

Alarm conditions can be defined using the EasyConnect configuration software.

Standard configuration: volume flow rate alarm.

Functional values

- 0 = No consolidated alarm
- 1 = Consolidated alarm

Data point

- BACnet: Binary Value Object – Instance BV-2
- Modbus: Bit list - bit 3 or register 32

PressAlarm

BMS access: RD

Equipment function:

- EASYLAB
 - RR with RMF, TAM with RMF
- TROX UNIVERSAL
 - RE/RS with RMF, PR*/PD* with RMF

Function

- Output of a room pressure alarm when room pressure control is active



Alarm conditions can be defined using the EasyConnect configuration software.

Functional values

- 0 = No differential pressure alarm
- 1 = Differential pressure alarm

Data point

- BACnet: Binary Value Object – Instance BV-3
- Modbus: Bit list - bit 4 or register 33

DI* (BACnet), StateDI (Modbus)

BMS access: RD

Equipment function:

- EASYLAB
 - FH, RR, RR with RMF, EC, SC, TAM, TAM with RMF
- TROX UNIVERSAL
 - RE/RS, RE/RS with RMF, PR*/PD*, PR*/PD* with RMF

Function

- Status of digital inputs DI1 – DI6 of the controller or adapter module

Data point

- BACnet: Binary Value Object – Instance BV-6 (DI1) – Instance BV-11 (DI6)
 - 0 = inactive
 - 1 = active
- Modbus: Register 39, bit 0 (DI1) – bit 5 (DI6)
 - Bit not set = inactive
 - Bit set = active

DO* (BACnet), StateDO (Modbus)

BMS access: RD

Equipment function:

- EASYLAB
 - FH, RR, RR with RMF, EC, SC, TAM, TAM with RMF
- TROX UNIVERSAL
 - RE/RS, RE/RS with RMF, PR*/PD*, PR*/PD* with RMF

Function

- Status of digital outputs DO1 – DO6 of the controller or adapter module

Data point

- BACnet: Binary Value Object – Instance BV-12 (DO1) – Instance BV-17 (DO6)
 - 0 = inactive
 - 1 = active
- Modbus: Register 40, bit 0 (DO1) – bit 5 (DO6)
 - Bit not set = inactive
 - Bit set = active

SC_Alarm

Equipment function: not available

DO*_SetByLocal (BACnet), DO_SetByLocal (Modbus)

BMS access: RD

Equipment function:

- EASYLAB
 - FH, RR, RR with RMF, EC, SC, TAM, TAM with RMF
- TROX UNIVERSAL
 - RE/RS, RE/RS with RMF, PR*/PD*, PR*/PD* with RMF

Function

- Feedback from the controller about switch outputs DO1 ... DO6 used by the controller or adapter module

Data point

- BACnet:
Binary Value Object – Instance BV-25 (DO1_SetbyLocal) – Instance BV-30 (DO6_SetbyLocal)
 - 0 = output inactive
 - 1 = output active
- Modbus:
Register 62, bit 0 (DO1_Set) – bit 5 (DO6_Set)
 - Bit not set = output inactive
 - Bit set = output active

LocalAlarm_*

BMS access: RD

Equipment function:

- EASYLAB
 - FH, RR, RR with RMF, EC, SC, TAM, TAM with RMF
- TROX UNIVERSAL
 - RE/RS, RE/RS with RMF, PR*/PD*, PR*/PD* with RMF

Function

- Output of the local alarm of the bus user, addressed by device ID, i.e. ID 4 ⇔ LocalAlarm_3

Data point

- BACnet:
Binary Value Object – Instance BV-31 (LocalAlarm_0) – Instance BV-54 (LocalAlarm_23)
 - 0 = No alarm
 - 1 = Alarm
- Modbus:
Register 63 - bit 0 (LocalAlarm_0) – bit 7 (LocalAlarm_7)
Register 64 - bit 0 (LocalAlarm_8) – bit 7 (LocalAlarm_15)
Register 65 - bit 0 (LocalAlarm_16) – bit 7 (LocalAlarm_23)
 - Bit not set = inactive
 - Bit set = active

DampPosMaxState_FH

BMS access: RD

Equipment function:

- EASYLAB
 - FH, RR, RR with RMF, EC, SC, TAM, TAM with RMF
- TROX UNIVERSAL
 - not used

Function

- Output of the status of the fume cupboard controller with the widest open damper blade ⁴
- For the evaluation of the damper blade positions in separate extract air systems (2 fans), i.e. fume cupboard extract air and room extract air

Data point

- BACnet: Multistate Value Object – Instance MV-11
- Modbus: Register 16

DampPosMinState_FH

BMS access: RD

Equipment function:

- EASYLAB
 - FH, RR, RR with RMF, EC, SC, TAM, TAM with RMF
- TROX UNIVERSAL
 - not used

Function

- Output of the status of the fume cupboard controller with the least wide open damper blade ⁵
- For the evaluation of the damper blade positions in separate extract air systems (2 fans), i.e. fume cupboard extract air and room extract air

Data point

- BACnet: Multistate Value Object – Instance MV-12
- Modbus: Register 18

DampPosMaxState_RE

BMS access: RD

Equipment function:

- EASYLAB
 - FH, RR, RR with RMF, EC, SC, TAM, TAM with RMF
- TROX UNIVERSAL
 - not used

Function

- Output of the status of the room extract air controller with the widest open damper blade ⁴
- For the evaluation of the damper blade positions in separate extract air systems (2 fans), i.e. fume cupboard extract air and room extract air

Data point

- BACnet: Multistate Value Object – Instance MV-13
- Modbus: Register 20

DampPosMinState_RE

BMS access: RD

Equipment function:

- EASYLAB
 - FH, RR, RR with RMF, EC, SC, TAM, TAM with RMF
- TROX UNIVERSAL
 - not used

Function

- Output of the status of the room extract air controller with the least wide open damper blade ⁵
- For the evaluation of the damper blade positions in separate extract air systems (2 fans), i.e. fume cupboard extract air and room extract air

Data point

- BACnet: Multistate Value Object – Instance MV-14
- Modbus: Register 22

DampPosMaxState_TE

BMS access: RD

Equipment function:

- EASYLAB
 - FH, RR, RR with RMF, EC, SC, TAM, TAM with RMF
- TROX UNIVERSAL
 - not used

Function

- Output of the status of the fume cupboard, extract air or room extract air controller with the widest open damper blade ⁴
- For the evaluation of the damper blade positions in separate extract air systems (2 fans), i.e. fume cupboard extract air and room extract air

Data point

- BACnet: Multistate Value Object – Instance MV-15
- Modbus: Register 24

DampPosMinState_TE

BMS access: RD

Equipment function:

- EASYLAB
 - FH, RR, RR with RMF, EC, SC, TAM, TAM with RMF
- TROX UNIVERSAL
 - not used

Function

- Output of the status of the fume cupboard, extract air or room extract air controller with the least wide open damper blade ⁵
- For the evaluation of the damper blade positions in separate extract air systems (2 fans), i.e. fume cupboard extract air and room extract air

Data point

- BACnet: Multistate Value Object – Instance MV-16
- Modbus: Register 26

DampPosMaxState_RS

BMS access: RD

Equipment function:

- EASYLAB
 - FH, RR, RR with RMF, EC, SC, TAM, TAM with RMF
- TROX UNIVERSAL
 - not used

Function

- Output of the status of the room supply air controller with the widest open damper blade ⁴

Data point

- BACnet: Multistate Value Object – Instance MV-17
- Modbus: Register 28

DampPosMinState_RS

BMS access: RD

Equipment function:

- EASYLAB
 - FH, RR, RR with RMF, EC, SC, TAM, TAM with RMF
- TROX UNIVERSAL
 - not used

Function

- Output of the status of the room supply air controller with the least wide open damper blade ⁵

Data point

- BACnet: Multistate Value Object – Instance MV-18
- Modbus: Register 30

DampPosMaxState_EC

BMS access: RD

Equipment function:

- EASYLAB
 - FH, RR, RR with RMF, EC, SC, TAM, TAM with RMF
- TROX UNIVERSAL
 - not used

Function

- Output of the status of the extract air controller with the widest open damper blade ⁴

Data point

- BACnet: Multistate Value Object – Instance MV-26
- Modbus: Register 50

DampPosMinState_EC

BMS access: RD

Equipment function:

- EASYLAB
 - FH, RR, RR with RMF, EC, SC, TAM, TAM with RMF
- TROX UNIVERSAL
 - not used

Equipment function: FH, RR, RR with RMF, EC, SC, TAM, TAM with RMF

Function

- Output of the status of the extract air controller with the least wide open damper blade ⁵

Data point

- BACnet: Multistate Value Object – Instance MV-27
- Modbus: Register 52

DampPosMaxState_SC

BMS access: RD

Equipment function:

- EASYLAB
 - FH, RR, RR with RMF, EC, SC, TAM, TAM with RMF
- TROX UNIVERSAL
 - not used

Function

- Output of the status of the supply air controller with the widest open damper blade ⁴

Data point

- BACnet: Multistate Value Object – Instance MV-28
- Modbus: Register 54

DampPosMinState_SC

BMS access: RD

Equipment function:

- EASYLAB
 - FH, RR, RR with RMF, EC, SC, TAM, TAM with RMF
- TROX UNIVERSAL
 - not used

Function

- Output of the status of the supply air controller with the least wide open damper blade ⁵

Data point

- BACnet: Multistate Value Object – Instance MV-29
- Modbus: Register 56

DampPosMaxState_TS

BMS access: RD

Equipment function:

- EASYLAB
 - FH, RR, RR with RMF, EC, SC, TAM, TAM with RMF
- TROX UNIVERSAL
 - not used

Function

- Output of the status of the supply air or room supply air controller with the widest open damper blade ⁴

Data point

- BACnet: Multistate Value Object – Instance MV-30
- Modbus: Register 58

DampPosMinState_TS

BMS access: RD

Equipment function:

- EASYLAB
 - FH, RR, RR with RMF, EC, SC, TAM, TAM with RMF
- TROX UNIVERSAL
 - not used

Function

- Output of the status of the supply air or room supply air controller with the least wide open damper blade ⁵

Data point

- BACnet: Multistate Value Object – Instance MV-31
- Modbus: Register 60

DampPosMaxState_VE

BMS access: RD

Equipment function:

- EASYLAB
 - not used
- TROX UNIVERSAL
 - RE/RS, RE/RS with RMF, PR*/PD*, PR*/PD* with RMF

Function

- Output of the status of the Universal extract air controller with the widest open damper blade ⁴

Data point

- BACnet: Multistate Value Object – Instance MV-32
- Modbus: Register 120

DampPosMinState_VE

BMS access: RD

Equipment function:

- EASYLAB
 - not used
- TROX UNIVERSAL
 - RE/RS, RE/RS with RMF, PR*/PD*, PR*/PD* with RMF

Function

- Output of the status of the Universal extract air controller with the least wide open damper blade ⁵

Data point

- Multistate Value Object – Instance MV-33
- Modbus: Register 122

DampPosMaxState_VS

BMS access: RD

Equipment function:

- EASYLAB
 - not used
- TROX UNIVERSAL
 - RE/RS, RE/RS with RMF, PR*/PD*, PR*/PD* with RMF

Function

- Output of the status of the Universal supply air controller with the widest open damper blade ⁴

Data point

- BACnet: Multistate Value Object – Instance MV-34
- Modbus: Register 124

DampPosMinState_VS

BMS access: RD

Equipment function:

- EASYLAB
 - not used
- TROX UNIVERSAL
 - RE/RS, RE/RS with RMF, PR*/PD*, PR*/PD* with RMF

Function

- Output of the status of the Universal supply air controller with the least wide open damper blade ⁵

Data point

- BACnet: Multistate Value Object – Instance MV-35
- Modbus: Register 124

DampPosMaxState_PKE

BMS access: RD

Equipment function:

- EASYLAB
 - not used
- TROX UNIVERSAL
 - RE/RS, RE/RS with RMF, PR*/PD*, PR*/PD* with RMF

Function

- Output of the status of the Universal differential pressure controller – extract air – with the widest open damper blade ⁴

Data point

- BACnet: Multistate Value Object – Instance MV-36
- Modbus: Register 128

DampPosMinState_PKE

BMS access: RD

Equipment function:

- EASYLAB
 - not used
- TROX UNIVERSAL
 - RE/RS, RE/RS with RMF, PR*/PD*, PR*/PD* with RMF

Function

- Output of the status of the Universal differential pressure controller – extract air – with the least wide open damper blade ⁵

Data point

- BACnet: Multistate Value Object – Instance MV-37
- Modbus: Register 130

DampPosMaxState_PKS

BMS access: RD

Equipment function:

- EASYLAB
 - not used
- TROX UNIVERSAL
 - RE/RS, RE/RS with RMF, PR*/PD*, PR*/PD* with RMF

Function

- Output of the status of the Universal differential pressure controller – supply air – with the widest open damper blade ⁴

Data point

- BACnet: Multistate Value Object – Instance MV-38
- Modbus: Register 132

DampPosMinState_PKS

BMS access: RD

Equipment function:

- EASYLAB
 - not used
- TROX UNIVERSAL
 - RE/RS, RE/RS with RMF, PR*/PD*, PR*/PD* with RMF

Function

- Output of the status of the Universal differential pressure controller – supply air – with the least wide open damper blade ⁵

Data point

- BACnet: Multistate Value Object – Instance MV-39
- Modbus: Register 134

DampPos

BMS access: RD

Equipment function:

- EASYLAB
 - FH, RR, RR with RMF, EC, SC
- TROX UNIVERSAL
 - RE/RS, RE/RS with RMF, PR*/PD*, PR*/PD* with RMF

Unit: %

Value range:

- BACnet: Percentage value in increments of 0.5 %
- Modbus: 0–200 (200 corresponds to 100 %)

Function

- Output of the damper blade position¹

Data point

- BACnet: Analog Value Object – Instance AV-10
- Modbus: Register 14

DampPosMax_FH

BMS access: RD

Equipment function:

- EASYLAB
 - FH, RR, RR with RMF, EC, SC, TAM, TAM with RMF
- TROX UNIVERSAL
 - not used

Unit: %

Value range:

- BACnet: Percentage value in increments of 0.5 %
- Modbus: 0–200 (200 corresponds to 100 %)

Function

- Output of the damper blade position of the fume cupboard controller with the widest open damper blade^{1, 2, 4}
- For the evaluation of the damper blade positions in separate extract air systems (2 fans), i.e. fume cupboard extract air and room extract air

Data point

- BACnet: Analog Value Object – Instance AV-11 – value and event state
- Modbus: Register 15 (value) and register 16 (event state)

DampPosMin_FH

BMS access: RD

Equipment function:

- EASYLAB
 - FH, RR, RR with RMF, EC, SC, TAM, TAM with RMF
- TROX UNIVERSAL
 - not used

Unit: %

Value range:

- BACnet: Percentage value in increments of 0.5 %
- Modbus: 0–200 (200 corresponds to 100 %)

Function

- Output of the damper blade position of the fume cupboard controller with the least wide open damper blade^{1, 2, 5}
- For the evaluation of the damper blade positions in separate extract air systems (2 fans), i.e. fume cupboard extract air and room extract air

Data point

- BACnet: Analog Value Object – Instance AV-12 – value and event state
- Modbus: Register 17 (value) and register 18 (event state)

DampPosMax_RE

BMS access: RD

Equipment function:

- EASYLAB
 - FH, RR, RR with RMF, EC, SC, TAM, TAM with RMF
- TROX UNIVERSAL
 - RE/RS, RE/RS with RMF, PR*/PD*, PR*/PD* with RMF

Unit: %

Value range:

- BACnet: Percentage value in increments of 0.5 %
- Modbus: 0–200 (200 corresponds to 100 %)

Function

- Output of the damper blade position of the room extract air controller with the widest open damper blade^{1, 2, 4}
- For the evaluation of the damper blade positions in separate extract air systems (2 fans), i.e. fume cupboard extract air and room extract air

Data point

- BACnet: Analog Value Object – Instance AV-13 – value and event state
- Modbus: Register 19 (value) and register 20 (event state)

DampPosMin_RE

BMS access: RD

Equipment function:

- EASYLAB
 - FH, RR, RR with RMF, EC, SC, TAM, TAM with RMF
- TROX UNIVERSAL
 - RE/RS, RE/RS with RMF, PR*/PD*, PR*/PD* with RMF

Unit: %

Value range:

- BACnet: percentage value in 0.5 % increments
- Modbus: 0–200 (200 corresponds to 100 %)

Function

- Output of the damper blade position of the room extract air controller with the least wide open damper blade ^{1, 2, 5}
- For the evaluation of the damper blade positions in separate extract air systems (2 fans), i.e. fume cupboard extract air and room extract air

Data point

- BACnet: Analog Value Object – Instance AV-14 – value and event state
- Modbus: Register 21 (value) and register 22 (event state)

DampPosMax_TE

BMS access: RD

Equipment function:

- EASYLAB
 - FH, RR, RR with RMF, EC, SC, TAM, TAM with RMF
- TROX UNIVERSAL
 - RE/RS, RE/RS with RMF, PR*/PD*, PR*/PD* with RMF

Unit: %

Value range:

- BACnet: Percentage value in increments of 0.5 %
- Modbus: 0–200 (200 corresponds to 100 %)

Function

- Output of the damper blade position of the fume cupboard, extract air or room extract air controller with the widest open damper blade ^{1, 3, 4}
- For the evaluation of the damper blade positions in the extract air system (1 fan) for fume cupboard and room extract air
- **For UNIVERSAL:** output of the damper blade position of the extract air room pressure controller in the system with the widest open damper blade ^{1, 3, 4}

Data point

- BACnet: Analog Value Object – Instance AV-15 – value and event state
- Modbus: Register 23 (value) and register 24 (event state)

DampPosMin_TE

BMS access: RD

Equipment function:

- EASYLAB
 - FH, RR, RR with RMF, EC, SC, TAM, TAM with RMF
- TROX UNIVERSAL
 - RE/RS, RE/RS with RMF, PR*/PD*, PR*/PD* with RMF

Unit: %

Value range:

- BACnet: Percentage value in increments of 0.5 %
- Modbus: 0–200 (200 corresponds to 100 %)

Function

- Output of the damper blade position of the fume cupboard, extract air or room extract air controller with the least wide open damper blade ^{1, 3, 5}
- For the evaluation of the damper blade positions in the extract air system (1 fan) for fume cupboard and room extract air
- **For UNIVERSAL:** output of the damper blade position of the extract air room pressure controller in the system with the widest closed damper blade ^{1, 3, 4}

Data point

- BACnet: Analog Value Object – Instance AV-16 – value and event state
- Modbus: Register 25 (value) and register 26 (event state)

DampPosMax_RS

BMS access: RD

Equipment function:

- EASYLAB
 - FH, RR, RR with RMF, EC, SC, TAM, TAM with RMF
- TROX UNIVERSAL
 - RE/RS, RE/RS with RMF, PR*/PD*, PR*/PD* with RMF

Unit: %

Value range:

- BACnet: Percentage value in increments of 0.5 %
- Modbus: 0–200 (200 corresponds to 100 %)

Function

- Output of the damper blade position of the room supply air controller with the widest open damper blade ^{1, 4}

Data point

- BACnet: Analog Value Object – Instance AV-17 – value and event state
- Modbus: Register 27 (value) and register 28 (event state)

DampPosMin_RS

BMS access: RD

Equipment function:

- EASYLAB
 - FH, RR, RR with RMF, EC, SC, TAM, TAM with RMF
- TROX UNIVERSAL
 - RE/RS, RE/RS with RMF, PR*/PD*, PR*/PD* with RMF

Unit:

Value range:

- BACnet: Percentage value in increments of 0.5 %
- Modbus: 0–200 (200 corresponds to 100 %)

Function

- Output of the damper blade position of the room supply air controller with the least wide open damper blade ^{1, 5}

Data point

- BACnet: Analog Value Object – Instance AV-18 – value and event state
- Modbus: Register 29 (value) and register 30 (event state)

DampPosMax_EC

BMS access: RD

Equipment function:

- EASYLAB
 - FH, RR, RR with RMF, EC, SC, TAM, TAM with RMF
- TROX UNIVERSAL
 - not used

Unit: %

Value range:

- BACnet: Percentage value in increments of 0.5 %
- Modbus: 0–200 (200 corresponds to 100 %)

Function

- Output of the damper blade position of the room extract air controller with the widest open damper blade ^{1,4}

Data point

- BACnet: Analog Value Object – Instance AV-26 – value and event state
- Modbus: Register 49 (value) and register 50 (event state)

DampPosMin_EC

BMS access: RD

Equipment function:

- EASYLAB
 - FH, RR, RR with RMF, EC, SC, TAM, TAM with RMF
- TROX UNIVERSAL
 - not used

Unit: %

Value range:

- BACnet: Percentage value in increments of 0.5 %
- Modbus: 0–200 (200 corresponds to 100 %)

Function

- Output of the damper blade position of the room extract air controller with the least wide open damper blade ^{1,5}

Data point

- BACnet: Analog Value Object – Instance AV-27 – value and event state
- Modbus: Register 51 (value) and register 52 (event state)

DampPosMax_SC

BMS access: RD

Equipment function:

- EASYLAB
 - FH, RR, RR with RMF, EC, SC, TAM, TAM with RMF
- TROX UNIVERSAL
 - not used

Unit: %

Value range:

- BACnet: Percentage value in increments of 0.5 %
- Modbus: 0–200 (200 corresponds to 100 %)

Function

- Output of the damper blade position of the supply air controller with the widest open damper blade ^{1,4}

Data point

- BACnet: Analog Value Object – Instance AV-28 – value and event state
- Modbus: Register 53 (value) and register 54 (event state)

DampPosMin_SC

BMS access: RD

Equipment function:

- EASYLAB
 - FH, RR, RR with RMF, EC, SC, TAM, TAM with RMF
- TROX UNIVERSAL
 - not used

Unit: %

Value range:

- BACnet: Percentage value in increments of 0.5 %
- Modbus: 0–200 (200 corresponds to 100 %)

Function

- Output of the damper blade position of the supply air controller with the least wide open damper blade ^{1,5}

Data point

- BACnet: Analog Value Object – Instance AV-29 – value and event state
- Modbus: Register 55 (value) and register 56 (event state)

DampPosMax_TS

BMS access: RD

Equipment function:

- EASYLAB
 - FH, RR, RR with RMF, EC, SC, TAM, TAM with RMF
- TROX UNIVERSAL
 - RE/RS, RE/RS with RMF, PR*/PD*, PR*/PD* with RMF

Unit: %

Value range:

- BACnet: Percentage value in increments of 0.5 %
- Modbus: 0–200 (200 corresponds to 100 %)

Function

- Output of the damper blade position of the supply air or room supply air controller with the widest open damper blade ^{1, 4}
- **For UNIVERSAL:** output of the damper blade position of the supply air duct pressure controller in the system with the widest open damper blade ^{1, 3, 4}

Data point

- BACnet: Analog Value Object – Instance AV-30 – value and event state
- Modbus: Register 57 (value) and register 58 (event state)

DampPosMin_TS

BMS access: RD

Equipment function:

- EASYLAB
 - FH, RR, RR with RMF, EC, SC, TAM, TAM with RMF
- TROX UNIVERSAL
 - RE/RS, RE/RS with RMF, PR*/PD*, PR*/PD* with RMF

Unit: %

Value range:

- BACnet: Percentage value in increments of 0.5 %
- Modbus: 0–200 (200 corresponds to 100 %)

Function

- Output of the damper blade position of the supply air or room supply air controller with the least wide open damper blade ^{1, 5}
- **For UNIVERSAL:** output of the damper blade position of the supply air duct pressure controller in the system with the widest closed damper blade ^{1, 3, 4}

Data point

- BACnet: Analog Value Object – Instance AV-31 – value and event state
- Modbus: Register 59 (value) and register 60 (event state)

DampPosMaxValue_VE

BMS access: RD

Equipment function:

- EASYLAB
 - not used
- TROX UNIVERSAL
 - RE/RS, RE/RS with RMF, PR*/PD*, PR*/PD* with RMF

Unit: %

Value range:

- BACnet: Percentage value in increments of 0.5 %
- Modbus: 0–200 (200 corresponds to 100 %)

Function

- Output of the damper blade position of the room extract air controller with the widest open damper blade ^{1, 4}

Data point

- BACnet: Analog Value Object – Instance AV-85 – value and event state
- Modbus: Register 119 (value) and register 120 (event state)

DampPosMinValue_VE

BMS access: RD

Equipment function:

- EASYLAB
 - not used
- TROX UNIVERSAL
 - RE/RS, RE/RS with RMF, PR*/PD*, PR*/PD* with RMF

Unit: %

Value range:

- BACnet: Percentage value in increments of 0.5 %
- Modbus: 0–200 (200 corresponds to 100 %)

Function

- Output of the damper blade position of the room extract air controller in the system with the widest closed damper blade ^{1,4}

Data point

- BACnet: Analog Value Object – Instance AV-86 – value and event state
- Modbus: Register 121 (value) and register 122 (event state)

DampPosMaxValue_VS

BMS access: RD

Equipment function:

- EASYLAB
 - not used
- TROX UNIVERSAL
 - RE/RS, RE/RS with RMF, PR*/PD*, PR*/PD* with RMF

Unit: %

Value range:

- BACnet: Percentage value in increments of 0.5 %
- Modbus: 0–200 (200 corresponds to 100 %)

Function

- Output of the damper blade position of the supply air controller with the widest open damper blade ^{1,4}

Data point

- BACnet: Analog Value Object – Instance AV-87 – value and event state
- Modbus: Register 123 (value) and register 124 (event state)

DampPosMinValue_VS

BMS access: RD

Equipment function:

- EASYLAB
 - not used
- TROX UNIVERSAL
 - RE/RS, RE/RS with RMF, PR*/PD*, PR*/PD* with RMF

Unit: %

Value range:

- BACnet: Percentage value in increments of 0.5 %
- Modbus: 0–200 (200 corresponds to 100 %)

Function

- Output of the damper blade position of the room supply air controller in the system with the widest closed damper blade ^{1,4}

Data point

- BACnet: Analog Value Object – Instance AV-88 – value and event state
- Modbus: Register 125 (value) and register 126 (event state)

DampPosMaxValue_PKE

BMS access: RD

Equipment function:

- EASYLAB
 - not used
- TROX UNIVERSAL
 - RE/RS, RE/RS with RMF, PR*/PD*, PR*/PD* with RMF

Unit: %

Value range:

- BACnet: Percentage value in increments of 0.5 %
- Modbus: 0–200 (200 corresponds to 100 %)

Function

- Output of the damper blade position of the extract air pressure controller in the system with the widest open damper blade ^{1,4}

Data point

- BACnet: Analog Value Object – Instance AV-89 – value and event state
- Modbus: Register 127 (value) and register 128 (event state)

DampPosMinValue_PKE

BMS access: RD

Equipment function:

- EASYLAB
 - not used
- TROX UNIVERSAL
 - RE/RS, RE/RS with RMF, PR*/PD*, PR*/PD* with RMF

Unit: %

Value range:

- BACnet: Percentage value in increments of 0.5 %
- Modbus: 0–200 (200 corresponds to 100 %)

Function

- Output of the damper blade position of the extract air pressure controller in the system with the widest closed damper blade ^{1,4}

Data point

- BACnet: Analog Value Object – Instance AV-90 – value and event state
- Modbus: Register 129 (value) and register 130 (event state)

DampPosMaxValue_PKS

BMS access: RD

Equipment function:

- EASYLAB
 - not used
- TROX UNIVERSAL
 - RE/RS, RE/RS with RMF, PR*/PD*, PR*/PD* with RMF

Unit: %

Value range:

- BACnet: Percentage value in increments of 0.5 %
- Modbus: 0–200 (200 corresponds to 100 %)

Function

- Output of the damper blade position of the supply air pressure controller in the system with the widest open damper blade ^{1,4}

Data point

- BACnet: Analog Value Object – Instance AV-91 – value and event state
- Modbus: Register 131 (value) and register 132 (event state)

DampPosMinValue_PKS

BMS access: RD

Equipment function:

- EASYLAB
 - not used
- TROX UNIVERSAL
 - RE/RS, RE/RS with RMF, PR*/PD*, PR*/PD* with RMF

Unit: %

Value range:

- BACnet: Percentage value in increments of 0.5 %
- Modbus: 0–200 (200 corresponds to 100 %)

Function

- Output of the damper blade position of the extract air pressure controller in the system with the widest closed damper blade ^{1,4}

Data point

- BACnet: Analog Value Object – Instance AV-92 – value and event state
- Modbus: Register 133 (value) and register 134 (event state)

¹ Damper blade positions DampPos**_** are transmitted as a percentage value between 0% (closed) and 100% (open).

² The output variables DampPosMax_FH, DampPosMin_FH, DampPosMax_EC, and DampPosMin_EC, as well as DampPosMax_RE and DampPosMin_RE are provided for the evaluation of the damper blade positions in separate extract air systems (3 fans) for fume cupboards, extract air and room extract air.

³ The output variables DampPosMax_TE and DampPosMin_TE are provided for the evaluation of the damper blade positions in the extract air system (1 fan) for fume cupboards, extract air and room extract air.

⁴ Status information for damper blade positions DampPosMax_**

- BACnet
 - Functional value = 1: All damper blades in OPEN position (special operating mode, value = 100%). Override not possible
 - Functional value = 2: All damper blades in standard operating mode. Override possible
 - Functional value = 3: At least one damper blade in OPEN position (special operating mode)
- Modbus Register: 16, 20, 24, 28
 - Event state = 0: All damper blades in standard operating mode. Override possible
 - Event state = -1 (FF): All damper blades in OPEN position (special operating mode, value = 100 %). Override not possible
 - Event state = 1: At least one damper blade in OPEN position (special operating mode)

⁵ Status information for damper blade positions DampPosMin_**

- BACnet
 - Functional value = 1: All damper blades in shut-off mode (special operating mode, value = 0%). Override not possible
 - Functional value = 2: All damper blades in standard operating mode. Override possible
 - Functional value = 3: At least one damper blade in shut-off mode (special operating mode)
- Modbus Register: 18, 22, 26, 30
 - Event state = 0: All damper blades in standard operating mode. Override possible
 - Event state = -1 (FF): All damper blades in shut-off mode (special operating mode, value = 0 %). Override not possible
 - Event state = 1: At least one damper blade in shut-off mode (special operating mode)

5 Maintenance

5.1 Maintenance plan

Interval	Maintenance work	Personnel
Every 5 years	Replacing the battery of the RTC module ↗ Chapter 5.2.1 'Replacing the battery of the RTC module' on page 71	Skilled qualified electrician

5.2 Maintenance

5.2.1 Replacing the battery of the RTC module

DANGER!

Danger of death due to electric current!

Danger of death if live components are touched.

- Switch off the supply voltage and secure it against being switched on again before working on the unit.
- Only skilled qualified electricians are allowed to work on live components.
- Equipotential bonding is required.

Personnel:

- Skilled qualified electrician

Protective equipment:

- Protective clothing
- Safety goggles

Materials:

- Button cell (type CR2032)

1. ▶ Open the housing cover on the EASYLAB/TROX UNIVERSAL controller or on the TAM adapter module (see installation and operating manual for the device).

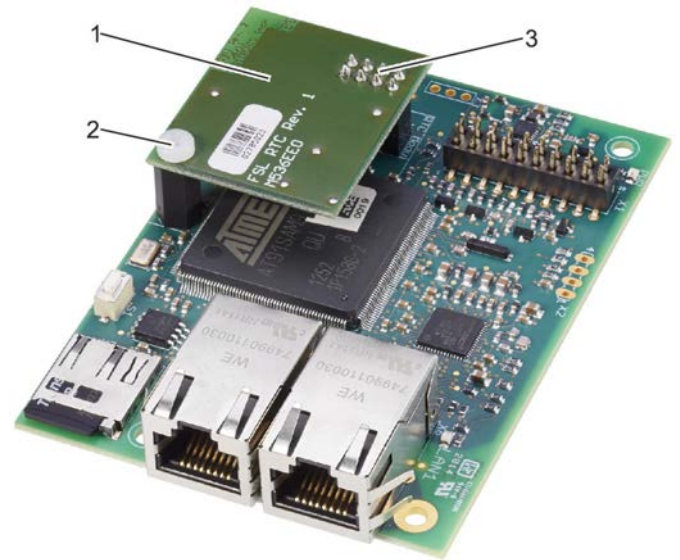

Fig. 46: Mounting the RTC module

2. ▶ Remove the fixing screw (Fig. 46/2) of the RTC module (Fig. 46/1).
3. ▶ Remove the RTC module from EM-IP.
4. ▶ Remove the button cell from the RTC module and insert a new one.
5. ▶ Slot the RTC module (Fig. 46/1) with the pins (Fig. 46/3) onto the 8-pole slot of EM-IP.
6. ▶ Fix the RTC module with the fixing screw (Fig. 46/2) to EM-IP.
7. ▶ Close the casing cover of the controller or adapter module (see installation and operating manual for the device).

5.2.2 Replacing the EM-IP expansion module

DANGER!

Danger of death due to electric current!

Danger of death if live components are touched.

- Switch off the supply voltage and secure it against being switched on again before working on the unit.
- Only skilled qualified electricians are allowed to work on live components.
- Equipotential bonding is required.

Personnel:

- Skilled qualified electrician

Protective equipment:

- Protective clothing
- Safety goggles

Materials:

- EM-IP expansion module
- Pin header

1. ▶ Open the housing cover on the EASYLAB/TROX UNIVERSAL controller or on the TAM adapter module (see installation and operating manual for the device).

Removing the optional RTC module

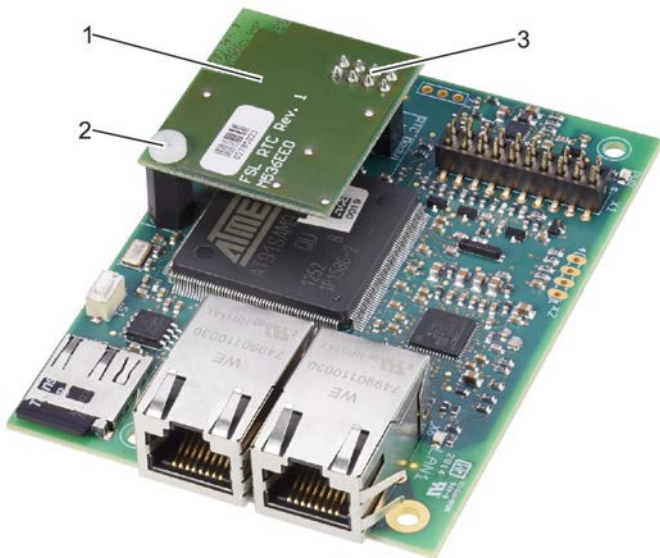

Fig. 47: Removing the RTC module

2. ▶ Remove the fixing screw (Fig. 47/2) of the RTC module (Fig. 47/1).
3. ▶ Remove the RTC module from EM-IP.

Removing the ground strap

Fig. 48: Removing the ground strap

4. ▶ Remove the fixing screw (Fig. 48/1) and washer (Fig. 48/2), then detach the ground strap (Fig. 48/4) from EM-IP (Fig. 48/3).

Removing EM-IP

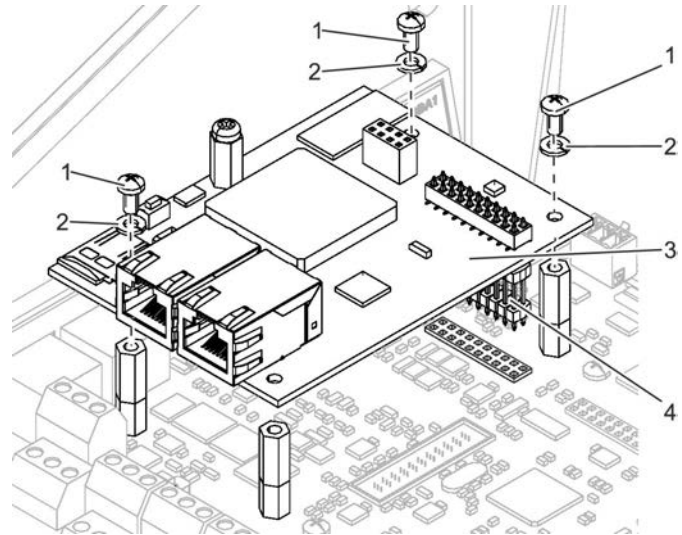

Fig. 49: Removing EM-IP

5. ▶ Remove the fixing screws (Fig. 49/1) and washers (Fig. 49/2), then remove EM-IP (Fig. 49/3) with the pin header (Fig. 49/4).

Mounting a new EM-IP expansion module

Fitting the pin header

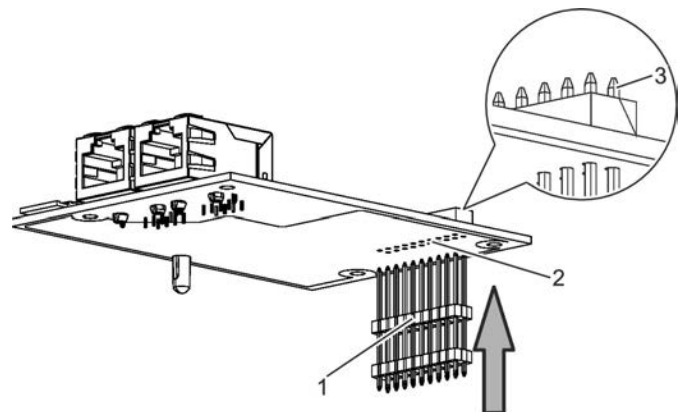

Fig. 50: Fitting the pin header

1. ▶ Take the pin header (Fig. 50/1) and push it with the longer ends from below through the EM-IP expansion module (Fig. 50/2).



Push the pin header just far enough so that the pins protrude slightly on the upper side (Fig. 50/3).

Installing EM-IP

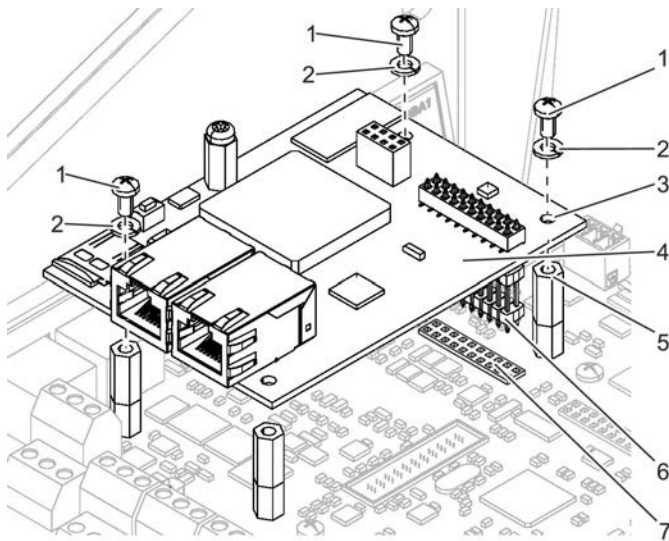

Fig. 51: Installing EM-IP

2. ▶ Place EM-IP (Fig. 51/4) with the pin header (Fig. 51/6) in the slot (Fig. 51/7) on the TCU3 or TAM main PCB.

i
Gently push the four corners of EM-IP onto the distance pieces (Fig. 51/5).

3. ▶ Screw-fix EM-IP with 3 fixing screws (Fig. 51/1) and washers (Fig. 51/2) to the main PCB as shown in Fig. 51.

! NOTICE!
Tighten the fixing screws only hand-tight!

Fixing the ground strap

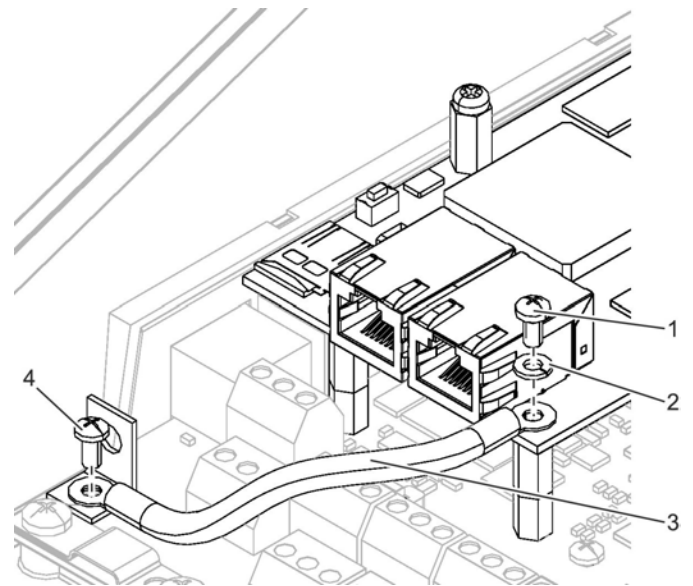

Fig. 52: Fixing the ground strap

4. ▶ Fix the ground strap (Fig. 52/3) with the fixing screw (Fig. 52/1) and the washer (Fig. 52/2) to EM-IP.
5. ▶ Fix the other end of the ground strap (Fig. 52/3) with a fixing screw (Fig. 52/4) to the earth connection on the main PCB.

! NOTICE!
Tighten the fixing screw only hand-tight!

Mounting the RTC module (optional)

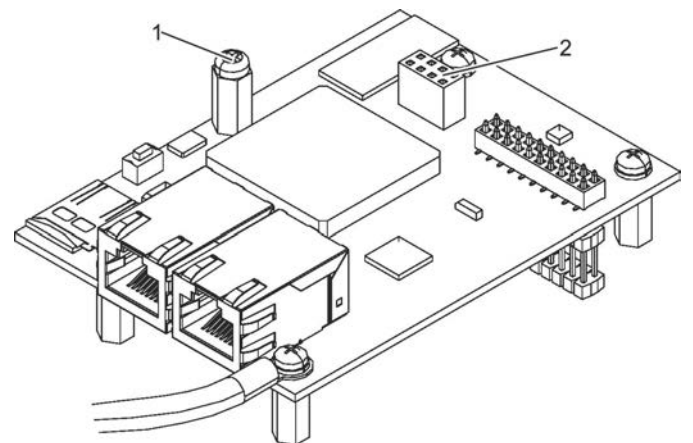

Fig. 53: Fixing screw

6. ▶ Remove the fixing screw (Fig. 53/1).

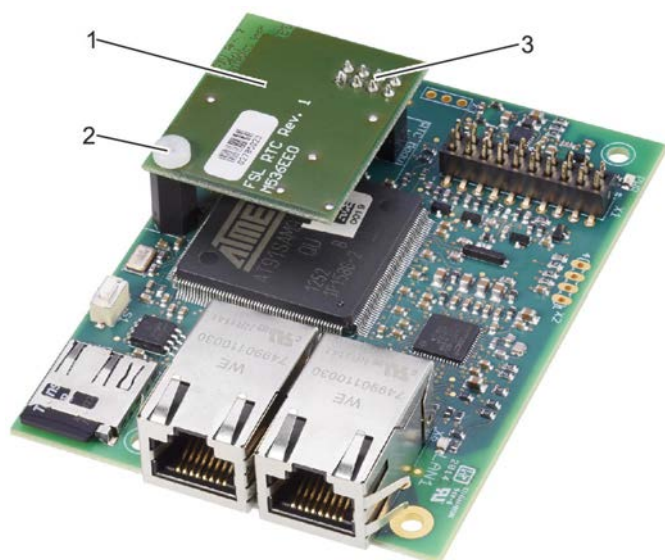

Fig. 54: Mounting the RTC module

7. ▶ Slot the RTC module (Fig. 54/1) with the pins (Fig. 54/3) onto the 8-pole slot (Fig. 53/2) of EM-IP.
8. ▶ Fix the RTC module with the fixing screw (Fig. 54/2) to EM-IP.

Connecting the network cable

9. ▶ Connect the network cable to EM-IP ↪ Installation manual

Closing the casing cover

10. ▶ Close the casing cover of the controller or adapter module (see installation and operating manual for the device).

5.2.3 Before re-commissioning

After you have completed any maintenance work and before you start using the equipment again, please note:

- Make sure that all components have been correctly mounted.
- Make sure that no tools or materials have been left in the controller casing.
- Make sure that the cover of the controller casing has been closed tightly.

6 Fault displays

6.1 LED status display

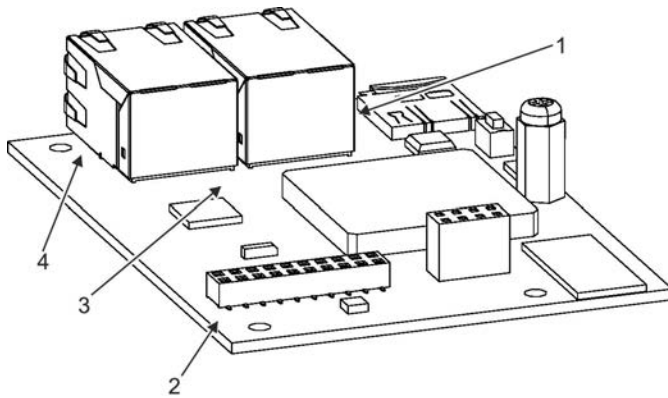

Fig. 55: LED fault display

Faults are first indicated by 4 LEDs on EM-IP.

The LEDs indicate the following:

Power LED (Fig. 55/2)	Operating status
LED green	Voltage is supplied
LED off	No voltage is supplied

Status LED (Fig. 55/3)	Operating status
LED green	Reset button is being pressed
LED green, blinking	Normal operation
LED red/green, blinking	DHCP mode is active
LED orange	Boot phase of EM-IP
LED orange, blinking	No configuration available
LED red	All files are being closed, then the module is rebooted.

LAN 1/LAN 2 LED (Fig. 55/1 und 4)	Operating status
LED green	Connection to the network
LED green, blinking	Data transmission in progress

6.2 Webserver

To display diagnosis options [↪ Chapter 3.5.8 'Functions of the 'Help' menu' on page 25](#), go to the menu bar of the web server and then to 'Help'.



These functions are available to Admin only. Other users cannot access this menu.

7 Index

A

Activating the DHCP server.....	8
Admin.....	10
Alarm management.....	20
Analysis	
Setup.....	17

B

BACnet	
Modbus.....	37
BACnet/IP.....	15, 22
BACnet description.....	15
BACnet network.....	23
BBMD/FD.....	23
Browser.....	10

C

Changing passwords.....	18
Configuration.....	8
Configuration manual (PDF).....	10
Copyright.....	3
Correct use.....	5

D

Damage to property.....	6
Data	
Backup.....	20
Loading an update.....	20
Restore.....	20

Defects liability.....	3
Device object properties.....	22
Display name.....	15

E

Electric current.....	5
Electrostatic charge.....	6
Environmental protection	
Batteries.....	6
Electrical and electronic parts.....	6
Rechargeable batteries.....	6

F

Fault displays	
LED status display.....	75
Webserver.....	75
Faults.....	75

G

Gateway type.....	15
General settings.....	15
Guest.....	10

H

Hotline.....	3
--------------	---

I

Incorrect use.....	5
Interface information	
BACnet.....	26
IP address.....	8
IP settings.....	10

L

Limitation of liability.....	3
Login.....	11

M

Mac OS X.....	10
Maintenance.....	71
Maintenance plan.....	71
Menu	

Analysis.....	14
Attachments.....	12
Events.....	14
Help.....	25
Setup.....	15
Microsoft Windows.....	10
Modbus/TCP.....	15
Modbus network.....	22

N

Network settings.....	20
NTP receiver.....	19

O

Other applicable documentation.....	3
-------------------------------------	---

P

Passwords.....	6, 10
Plant views	
Setup.....	16

Q

Qualification.....	6
--------------------	---

R

Reboot.....	8, 21
Replacing the battery.....	71
Replacing the EM-IP expansion module.....	72
Reset push button.....	8
Residual risks.....	5
Restoring the factory settings.....	8
RTC module.....	71

S

Security.....	5
Service.....	3
Settings.....	15
Signs.....	5
Slave address.....	22
Software version.....	8

Staff.....	6	Time synchronisation.....	19
Standard IP address.....	8, 10	U	
Supported browsers.....	10	UDP port.....	23
Supported users.....	10	Update	20
Symbols.....	5	User	10
Synchronisation.....	19	User administration.....	18
System owner's obligations.....	6	W	
System time.....	18	Web interface.....	10
T		display.....	11
TCP port.....	22	Webserver.....	15
Technical service.....	3	Web server.....	8, 10, 11
Temperature differences.....	6	Windows.....	10

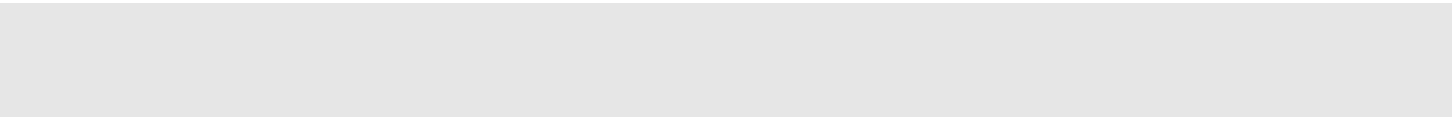

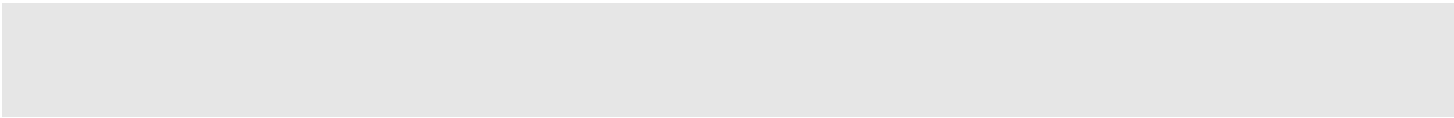

TROX[®] TECHNİK

The art of handling air

TROX GmbH

Heinrich-Trox-Platz

47504 Neukirchen-Vluyn, Ger-
many

Germany

+49 2845 202-0

+49 2845 202-265

trox@trox.de

<http://www.troxtechnik.com>

© TROX GmbH 2017